



This manual was not subject to any language revision.

This manual or any part of it may not be copied, reproduced  
or otherwise distributed without the publisher's consent.

All rights reserved. Elcom, s.r.o.

© ELCOM s. r. o., 2009

# CONTENTS

<b>INTRODUCTION</b> .....	<b>7</b>
<b>Important notices</b> .....	<b>8</b>
<b>Basic definitions</b> .....	<b>9</b>
Logo .....	9
Departments .....	9
Tax level .....	9
Sales units .....	10
PLU .....	10
The connection between departments and PLUs .....	10
Reports .....	10
Bar codes .....	10
The bar-code scanner .....	11
Cumulative totals (grand totals) .....	11
Concepts defining the launch of the euro currency, or payment in a foreign currency .....	11
Conversion rate .....	11
Dual display .....	11
Dual cash circulation .....	12
Primary currency .....	12
Foreign (secondary) currency .....	12
Dual currencies .....	12
<b>CASH REGISTER CHARACTERISTICS</b> .....	<b>13</b>
<b>Parts of the cash register, basic parameters</b> .....	<b>14</b>
<b>Attaching peripheral devices</b> .....	<b>15</b>
<b>The Euro-50TE Mini cash register keyboard</b> .....	<b>16</b>
Names and functions of buttons (keys) .....	16
<b>Description of displays</b> .....	<b>17</b>
Description of the cashier display .....	17
Description of the customer display .....	18
<b>Entering cash register modes</b> .....	<b>18</b>
<b>Installation of the Paper tape</b> .....	<b>19</b>
Usage and storage of paper ribbons .....	20
<b>Using a memory card</b> .....	<b>20</b>
Setting the display contrast : .....	20
<b>PROGRAMMING THE CASH REGISTER</b> .....	<b>21</b>
<b>Initialization</b> .....	<b>22</b>
<b>General procedure when programming in "P" mode</b> .....	<b>22</b>
Basic rules for navigating in a menu .....	22
Printing of programmed values .....	23
Revision of programmed values .....	23
Editing text in EditMode .....	23
Recommended procedure when programming the cash register .....	23
<b>Price and tax parameters</b> .....	<b>24</b>
Overview of individual price and tax parameters .....	25
Settings for prices .....	25
Settings for cash .....	25
Settings for taxes .....	25
<b>OPERATION IN REGISTRATION MODE</b> .....	<b>39</b>
<b>Status and functions which are required to know prior to the start of ringing sales</b> .....	<b>40</b>

Error warning - the CLEAR key .....	40
Keys for finalising payment with CASH, CHECK and CREDIT .....	40
Cashier login .....	40
Switch operator .....	40
<b>Registration mode menu .....</b>	<b>40</b>
<b>Examples of basic accounting procedures .....</b>	<b>41</b>
<b>PLU registration .....</b>	<b>42</b>
Basic PLU registration .....	42
Repeated registration of an item .....	42
Multiplication in PLU registration .....	43
PLU registration using a price not programmed .....	43
Multiplication in PLU registration using a price not programmed .....	43
Double multiplication in PLU registering .....	43
Fractional PLU registration .....	44
<b>Other types of PLU sales .....</b>	<b>44</b>
Linked PLUs registration .....	44
Registering of refundable packaging .....	44
Registration using bar codes .....	45
Entering amounts using electronic scales .....	45
<b>Corrections and voids .....</b>	<b>46</b>
Clearing .....	46
Voiding (cancellations) .....	46
Percent surcharge/discount on a subtotal .....	48
Value surcharges and value discounts .....	49
<b>Refunds .....</b>	<b>50</b>
Refund of a product .....	50
Refund of a package .....	50
<b>Depositing cash .....</b>	<b>51</b>
<b>Withdrawal of cash or checks .....</b>	<b>52</b>
<b>Enter reference number .....</b>	<b>52</b>
<b>Registration using the euro currency .....</b>	<b>53</b>
Stage prior to announcement of the conversion rate .....	53
Stage of dual display .....	54
Stage of dual circulation - entry to the eurozone .....	55
Stage of mandatory dual display .....	55
The end of dual display .....	56
<b>Text journal .....</b>	<b>57</b>
<b>Binary Journal .....</b>	<b>57</b>
<b>REPORTS .....</b>	<b>61</b>
<b>Report modes .....</b>	<b>62</b>
<b>Generated reports .....</b>	<b>62</b>
<b>Report contents .....</b>	<b>62</b>
Financial reports .....	62
Daily financial X-report .....	62
Monthly financial X-report .....	63
Daily turnover .....	63
X - cashier report .....	63
PLU X-report .....	63
DPT X-report .....	63
X-Drawer report .....	63
Daily financial Z-report .....	63
Monthly financial Z-report .....	64

---

Z-cashier report .....	64
PLU Z-report .....	64
PLU X-report print out: .....	64
<b>How to print an X-report .....</b>	<b>64</b>
Sample printouts of an X-report .....	65
Z-Drawer report .....	66
DPT Z-report .....	66
Z- Combined report Name .....	66
<b>How to print out a Z-report.....</b>	<b>67</b>
Sample printouts of an Z-report .....	67
<b>OPTIONAL ACCESSORIES .....</b>	<b>69</b>
Digital scales.....	70
Bar-code scanners.....	70
MS-5145 Eclipse .....	70
Metrologic Orbit MS-7120.....	70
Metrologic MS-9520 Voyager .....	71
Birch CD-108e .....	71
<b>HELPFUL ADVICE .....</b>	<b>73</b>
<b>Helpful advice .....</b>	<b>74</b>
<b>Information and error messages .....</b>	<b>75</b>
<b>Testing the cash register.....</b>	<b>78</b>
Testing the electronic circuits and the display .....	78
Customer display .....	78
Cashier display .....	78
Testing the keyboard .....	79
Testing the printer .....	80
Testing the position of thermal printer head .....	80
Paper ribbon sensor test .....	81



# ***INTRODUCTION***

Thank you for choosing the Euro-50TE Mini electronic cash register. Before you begin using the cash register, read these instructions to become familiar with the register's features and functions. Be sure to save this manual for future use. It will help you resolve problems that may arise.

## **IMPORTANT NOTICES**



- Do not leave switched-on equipment unattended!
- Install the cash register in a place where it will not be exposed to direct sunlight, unusual changes in temperature (below 0 °C and over 45 °C) or high humidity. Installation in an unsuitable place could cause damage to the casing and electrical components.
- Prior to use, leave the cash register connected to the power adapter for at least 4 hours in order to charge the internal battery.
- When charging the battery, the external casing of the cash register may heat up; therefore, we recommend that it not be placed near inflammable materials.
- Upon carrying the cash register from a cool environment to a warm one, or vice versa, do not switch it on for at least 20 minutes.
- The cash register should not be operated by a person with wet hands. Water could penetrate to the interior and cause the failure of parts.
- Clean the cash register with a soft, dry cloth. Never use a cleaning agents such as petrol and other solvents. The use of such chemicals can lead to damage to the register casing or discoloration.
- Protect the register from being sprinkled or doused with liquids. Liquids can damage the functionality of the cash register. The register keyboard in particular should be thoroughly protected.
- Connect the cash register to a standard electrical socket (230V±10%) using the adapter provided. Some electrical equipment connected in the same network circuit can cause the improper functioning of the cash register. In such a case, use a special antijamming device recommended by the maker of the register.

**Notice:** The adapter is specified only for interior use!

- If the cash register is not working properly, take it to an authorised service center technician. Do not attempt to repair the cash register yourself. Do not open the cash register!
- If the equipment is to be fully disconnected from the electrical network, unplug the AC/DC adapter from its electric outlet.
- If an external adapter is connected to the cash register, the internal accumulator is charged even when the cash register is turned off.
- If a red streak appears at the end of the paper ribbon, change the ribbon as soon as possible. Changing the ribbon too late could damage to the printer or decrease its lifespan.
- Use a paper ribbon that is not glued at its end. If such a paper ribbon is used and not changed early enough, the printer could be damaged or its lifespan could be shortened. In such a case, the warranty for the damaged printer is no longer valid.
- We recommend using only high-quality thermal paper ribbons. Improper ribbons may damage the cash register printer or possibly shorten its lifespan. With the use of suitable ribbons and proper maintenance, the printer has an average lifespan up to 25 million printed lines! You can find detailed information in the chapter Usage and Storage of Paper Ribbons.
- Journal paper storage recommendations: Do not expose thermal paper to direct sunlight. Store at a temperature no higher than 40 °C. Avoid contact with PVC, mollifiers, organic solvents, glues and water. When taping a report into an accounts book, only press tape at the end of the paper ribbon in order not to damage the printed data. Paper ribbons must be kept in proper storage conditions in order to preserve data according to valid provisions.



It is important to use only paper ribbons which meet all of the required characteristics of the manufacturer. If storage conditions are not met or low-quality paper ribbons are used, the Elcom company cannot guarantee the quality of the printing nor the preservation of data.

- Use only the AC/DC adapter provided or an adapter recommended by an authorised dealer. The use of other types of adapters may result in damage to the adapter or the cash register.
- For communication between the cash register and a computer, use only the program recommended by your authorised dealer and the original connection cable for the cash register.
- If the cash register is used in different ways than those described in these instructions, the dealer cannot be responsible for any incorrect data or damage that may result.
- Only equipment which conforms to European Union standards (CE) should be connected to the Euro-50 Mini. In other cases, the Elcom company cannot guarantee the adherence to standards of whole system. Your authorised dealer or the Elcom company can inform you about the possibilities of connecting the Euro-50TE cash register with different equipment.
-  A symbol on the product or on its packaging indicates that this product, upon completion of its use, should not be treated as common household waste. Instead it should be handed over to a special take-back scheme for the recycling of electrical equipment and electronic components. By ensuring the proper disposal of this product, you will help preserve natural resources and help prevent potential negative consequences on the environment and on human health. You can get further details from your local office or from the nearest waste-collection centre.
-  The product contributes to environmental protection through the use of non-lead technology during its production.

## **BASIC DEFINITIONS**

### **Logo**

The heading of each printed receipt contains introductory information, followed by a description of the goods purchased. It is primarily used to identify the owner of the cash register (company name, address, tax information, company identification, etc.).

**Figure 1.1 – Receipt logo.**



### **Departments**

Departments (DPTs) are used to denote groups of goods having some common features (dairy products, foodstuffs, fruit, etc.) and is characterised by a name.

### **Tax level**

Tax level is used to determine the tax on the goods sold. It is characterised by a percent value.

## Sales units

Sales units are used in connection with the quantity of goods sold (metres, litres, etc.). Each PLU has a specific sales unit assigned which indicates the quantity of the goods sold. It is possible to program 8 specific sales units with a maximum of three characters.

## PLU

PLU (Price Look Up) is an abbreviation used to denote a specific product item. The PLU code represents the name of the product, the sale price, its bar code and flags (assignment to a department, VAT level, PLU type, etc.).

For example: whole milk - 13.50 EUR, plain yogurt - 7.50 EUR.

## The connection between departments and PLUs

The example in figure 1.2 clearly illustrates the relation between the departments and the product items (PLUs).

Figure 1.2 – The relation between departments and PLUs.

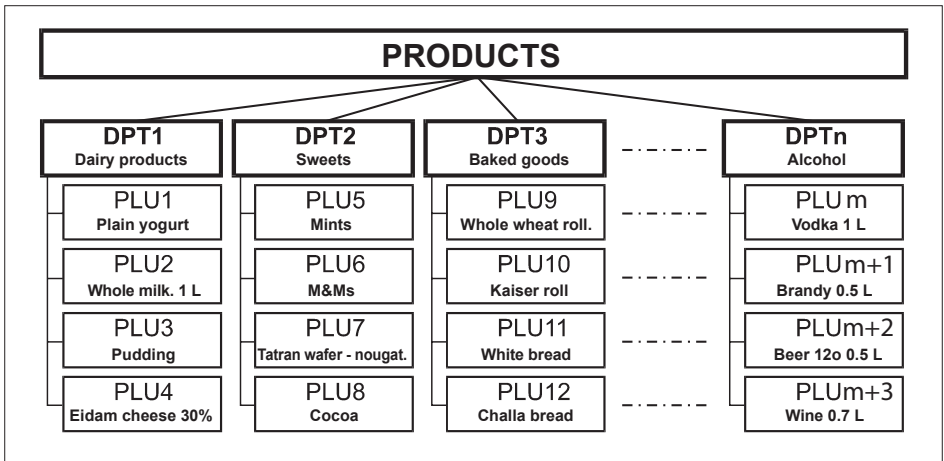

## Reports

Reports provide an overview of sales according to selected criteria (daily totals, periodical (e.g., monthly), etc.). There are two basic types of reports: „X“ and „Z“.

„X“ reports print out specific sales values (according to the report selected) without zeroing out this data in the cash register memory.

„Z“ reports print out the sales values of the selected report, and after the printing of these values, zeroes out the cash register memory.

**Notice:** According to valid Slovak legislation, a report in „Z“ mode must always be printed out at the end of each day.

## Bar codes

A bar code is a graphic encoding of a number signifying a product according to strictly defined international regulations. If a product has a bar code assigned, the bar code is depicted on each packaging for this product. The most frequently used codes for products in Europe are the 13-digit code according to the EAN norm (EAN - 13) and the 8-digit code (EAN-8). The Euro-50TE Mini cash register is also capable of working with EAN bar codes which contain an expanded 2 or 5-digit section.

Figure 1.3 – EAN Bar codes

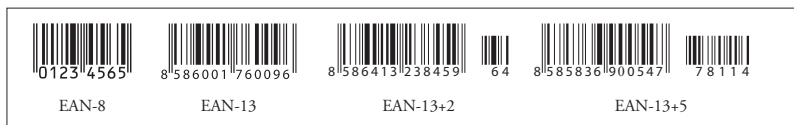

## The bar-code scanner

Equipment which ensures the scanning of a bar code. The device is used at the point-of-sale for the rapid and accurate registering of products being purchased.

Figure 1.4 – Bar-code scanner.



## Cumulative totals (grand totals)

Cumulative totals are variables that calculate the values of all sales. Three types of grand totals are generally known: GT1, GT2 and GT3, which are defined by Regulation no. 55/1994 Code of Laws on the method of recording sales through electronic cash registers, as amended, as follows:

GT1 - gross turnover - this means the cumulative total of all positive values registered in the electronic cash register (ECR).

GT2 - net turnover - is understood to be the difference between gross turnover and negative turnover.

GT3 - negative turnover - meaning the cumulative total of all negative values (refunded items), discounts and negative items registered in the ECR.

## Concepts defining the launch of the euro currency, or payment in a foreign currency

### Conversion rate

The conversion rate is the total irrevocable fixed exchange rate between the euro and the Slovak crown, which the Council of the Europe Union accepts according to special provisions and according to which the currency of the Slovak Republic will be replaced by the euro from the day the euro is introduced into the country.

### Dual display

The dual display of prices, payments and other values is the depiction and introduction of prices simultaneously in the Slovak currency as well as in the euro currency exclusively according to the fixed exchange rate and other regulations for the changeover from Slovak currency to the euro. Thus, prior to the day the euro is launched, monetary sums presented in Slovak crowns are at the same time introduced, for informational purposes, in euros, and from the day the euro is launched, including the day of its launch, sums presented in euros are also, for informational purposes, shown in Slovak crowns.

## **Dual cash circulation**

The period of dual cash circulation is designated as a temporary period of cash circulation in the Slovak Republic which begins on the day the euro is introduced and during which, by law, all cash payments made in the Slovak Republic may be made in any valid euro banknotes and coins, including commemorative euro coins, which were issued by the European Central Bank, the National Bank of Slovakia, elsewhere in the eurozone or in participating third-party states, and at the same time valid Slovak banknotes and coins, including commemorative Slovak coins which were issued by the National Bank of Slovakia and which were valid on the day the euro was introduced.

## **Primary currency**

The currency in which all important financial calculations are made and which for the authorised period of the transfer to the euro currency is valid by law in the Slovak Republic.

## **Foreign (secondary) currency**

An optional other currency serving for making payments and withdrawals concurrently with the primary currency. The cash register allows the recording of withdrawals and payments for one foreign currency. The foreign currency can be the euro currency or another such as, for example, the American dollar. During the phase of dual circulation of the euro currency and the Slovak crown, however, the foreign currency must be the Slovak crown.

## **Dual currencies**

The currency serving for informational calculation and display of monetary sums. It is generally not possible to make payments, deposits or withdrawals in this currency. This does not apply if the dual currency is identical to the foreign currency (dual cash circulation).

### **Note:**

*The concepts presented in this chapter come from the law on the introduction of the euro currency in the Slovak Republic. The wording of the law can be found on the Web page of the Government Plenipotentiary for the introduction of the euro: <http://www.euro.vlada.gov.sk/>*

***CASH REGISTER  
CHARACTERISTICS***

## PARTS OF THE CASH REGISTER, BASIC PARAMETERS

The Euro-50TE Mini cash register arises from the experience of many people successful in business. Using and programming the cash register is simple and intuitive thanks to its clearly arranged menu (see the MENU MAP in the chapter „Helpful Advice“).

The Euro-50TE Mini belongs to a family of portable cash registers. It is both light and compact. It is designed for smaller operations, portable sellers, or as a replacement register during electrical outages. It is also used in small grocery shops, drugstores, textile shop and larger over-the-counter operations - for example, stationery shops. Despite its small size, it is very well equipped technically.

Specific characteristic of the Euro50TE Mini is storing the control tape (journal) in electronic form and later, saving it on the memory card or download to computer.

The Euro-50TE Mini cash register can be powered by:

- an electrical network 230V ( $\pm 10\%$ ) via the power adapter supplied
- the built-in accumulator
- a car battery (12-V) by using a cable connection to the car's cigarette lighter.

The package includes the cash register, the adapter, the storage battery and a presentational CD.

The cash register fully supports the Slovak language and Slovak diacritical marks.

**Figure 2.1 – Basic features of the Euro-50TE Mini cash register**

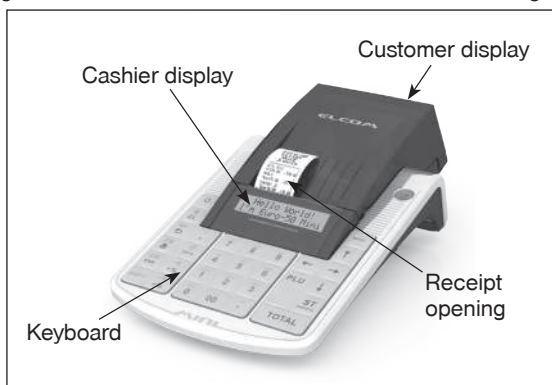

**Table 2.1 – Parameters of the Euro-50TE Mini cash register**

Designed for	all types of counter operations, smaller self-service sellers, sales stands, operations of services, taverns and bars
Number of PLUs	2 000
Number of DPTs	20
Number of cashiers	1
Tax levels	7
Printer	thermal, Seiko LPTZ-245
Average print speed	12 lines/s
Thermal paper ribbon	2 x 28 mm
Number of characters in PLU name	18
Number of characters in the logo line	18/9 (normal characters/double-sized characters)

Max logo lines	9 lines
Capital and small characters	yes
Bold characters	
Special characters	
Programming language	English
Receipts language	
Reports language	
Reports	daily, periodic (monthly)
Operational conditions	0-45 ° C, humidity of 80% with a temperature of 35 ° C and lower
Cashier display	alphanumeric, 2 * 16 characters
Customer display	10-characters LCD
PC interface	USB
Scales and scanner interface	RS-232 (optional)
Memory card *	SD card (not included)
Dimensions in mm	245 x 140 x 90 mm
Weight	0.650 kg
Power	adapter 100-240 V/12 V DC, 1A
Battery	1 800 mAh/7.4 V
Energy-saving mode	yes
Standard specifications	EN 55024, EN 61000-4-2, 3, 4, 5, 6, EN 61000-3-2, 3, EN55022 - class B

\* memory card serves for import and export of product items

## ATTACHING PERIPHERAL DEVICES

**Notice:** Your supplier can inform you about the possibilities of attaching peripheral devices.

**Figure 2.2 –Connectors to the Euro-50TE Mini cash register**



Connecting to a computer via a USB



Connecting a computer, scanner or electronic scales (2xRS-232, optional) and payment terminal

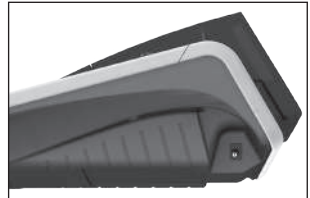

Connecting an adapter or other external power source

## THE EURO-50TE MINI CASH REGISTER KEYBOARD





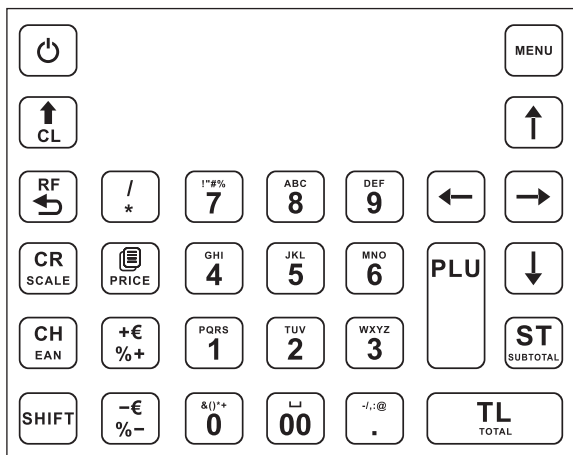

The cash register keyboard is divided into two basic key groups – numeric keys and function keys. If there are two functions on a single key, it is necessary to select individual functions as follows: the function on the lower part of the key is selected by simply pushing the key. To choose the upper function on the key, it is necessary to first push and hold the „SHIFT“ key, then press the desired function key. The keyboard is very comfortable and is ready for all-day operation. The keys are marked by large and simple icons for fast orientation.

Figure 2.3 – The Euro-50TE Mini keyboard



Notice: Use a clean, dry cloth to clean the keyboard. Never use cleaning agents such as petrol or solvents. The use of such chemicals can lead to damage to the keyboard or cause discoloration. If you need to clean a heavily soiled keyboard, we recommend using a 3M cleaning spray.

### Names and functions of buttons (keys)

-  NUMERICAL KEYS are used for entering numerical values and for entering text in the programming „P“ mode.
-  Holding down the SHIFT key and then pressing a key with dual functions selects the function written on the upper part of the key.
-  The CLEAR button is used to clear an amount that has been entered incorrectly from the numeric keyboard. This button also cancels an incorrectly entered function and the sound signalling ERROR/ALARM. It cancels incorrect letters when entering text.
-  The VOID button is used to correct an item that has already been registered. In the “P mode this button is used for printing out all active items on the given menu.
-  The REFUND button enables you to buy back returned packages during a sale or as an independent transaction.
-  Pressing the EAN button in the “R” and “T” mode allows you to ring a sale by directly entering the bar code reference number. In the “P” mode, pressing this button allows you to input the specific programmed values.





When the cash register is connected to an electric scale, the SCALE button is used to read the weight of the weighed goods. In the „P“ mode this key is used to print out all the programmed parameters in the given item.



The SHIFT key advances the receipt ribbon without printing. Pressing the button moves the paper ribbon by about 1.5 cm.



The MULTIPLY button is used for multiplication if two or more of the same item are being sold.



The DIVIDE button is used for sales of fractional amounts.



The PRICE button enables the manual entry of a price rather than registering the preprogrammed PLU price for one item. It is also used for fast PLU price programming in the “P” mode.



After completing a transaction, it is possible to print out a duplicate receipt by pressing the DUPLICATE button. The receipt is marked “DUPLICATE”.



The PLU button (PRICE LOOK UP) enables you to call up the programmed data about an item, price, name, department, VAT, etc..



The CREDIT button is used to finalise a sale when payment is made with a credit card.



The CHECK button is used to select the type of payment when payment is made by check. In the „P“ mode it is used to print out programmed data.



These two buttons are used for adding a percent surcharge or subtracting a percent discount for a given item or for a complete transaction according to the programmed values.



These two buttons are used for adding a value surcharge or subtracting a value discount for a given item or for a complete transaction.



The SUBTOTAL button displays and prints out the current subtotal value.



The TOTAL/CASH button is used to finalise a sale when payment is made in cash. In the cash register menu this button serves to transition to a sub-menu or confirmation of a selected/entered value.



The MENU button is used to call up the cash register menu. With the menu open, this key serves to shift the selected level up one line.



The arrow keys serve for movement within the cash register menus. In the “R” mode, upon opening a sale, the keys serve for the moving of individual registered product items.



The ON/OFF key is used for switching the cash register on and off. This key is also used to wake the cash register up from the Power-saving mode.

## DESCRIPTION OF DISPLAYS

### Description of the cashier display

The cashier display is a double-line LCD display with 16 characters per line.

Figure 2.4 – Alphanumeric LCD display







## Description of the customer display

The customer display of the Euro-50TE Mini is a 10-character, 7-segment LCD display.

Figure 2.5 – Division of the 7-segment LCD display



## ENTERING CASH REGISTER MODES

Pressing the button  (MENU) calls up the cash register's Main Menu, where by using the arrow keys , or  and subsequently confirming with the button  TOTAL, it is possible to select a cash register mode. Such mode switching allows a worker using the cash register to work in a variety of modes (registering sales, programming, printing reports, etc.).



Registration mode. This mode is used for all registering and sales transactions. Upon switching into this mode, the display shows the actual date in the first line and the actual time in the second line until registration of sales begins.

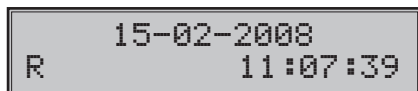

The „X“ mode is used to print out all types of sales reports, which do not zero-out the cash register's sales data.

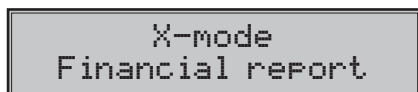

The „Z“ mode is used to print out all types of sales reports, which zero-out the cash register's sales data.

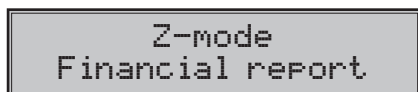

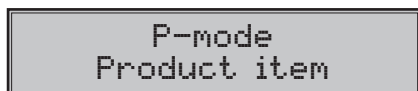

The „P“ mode is used for programming all values and functions of the cash register.

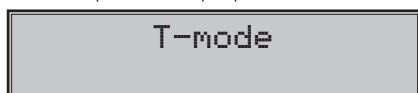

Training mode has all the functions of the „R“ mode, but operations performed in this mode are not calculated into reports. Receipts printed out in this mode are denoted with the text „Invalid document.“



„ÚSPORNÝ REŽIM“ Pokladnica sa prepne do úsporného režimu vtedy, keď sa v určenom časovom limite na nej nevykonáva žiadna činnosť. V úspornom režime má pokladnica nízku spotrebu energie. Na displeji je

zobrazený nápis „úsporný režim“. Všetky klávesy, okrem klávesu  (ON/OFF) button are non-functional in this mode. The power-saving mode is ended by pressing the  (ON/OFF) button.

POWER-SAVING mode

## INSTALLATION OF THE PAPER TAPE

The Euro-50TE Mini cash register uses one thermal paper tape with width 57mm. This tape is used for printing of the customer receipt. The cash register saves the control receipt in electronic form. We recommend to use only rolls of good quality with the maximum roll diameter of 45 mm. For good functionality of the cash register, make sure of the correct printing saturation. If any problems occur, contact your local authorized dealer of Euro-50TE Mini.

Figure 2.6 – Installation of paper ribbons into the cash register

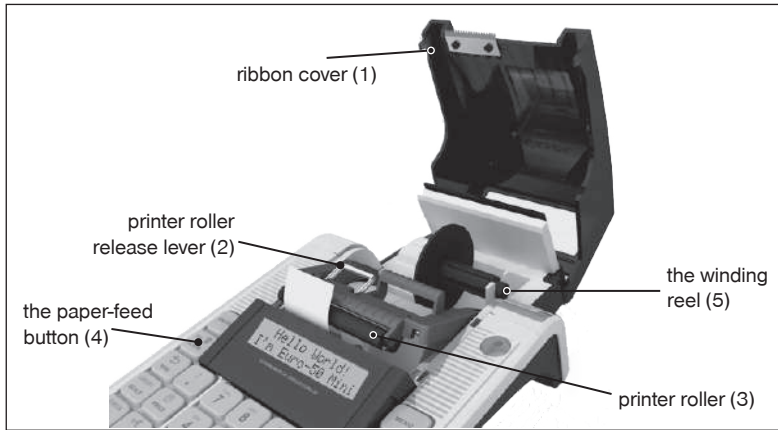

### Procedure of paper tape installation for Euro-50TE Mini ( according to Figure 2.6):

- By pulling the lever (2) open the paper cover and paper roller (3)
- Take out empty reel with the bar
- Put the new paper ribbon on bar and put it on the original place
- Hold the end of the paper over the operator display and close the paper cover (3) to its original position (you should hear a click at closing the paper roller (3) )
- Press the key for sliding the paper to ensure about the correct installation of the paper ribbon

Figure 2.7 –Opening the cover tape



## Usage and storage of paper ribbons

Conditions for the proper storage of thermal paper rolls supplied by Elcom s.r.o., with which the producer guarantees the consistency of the printer for at least 5 years:

- room temperature of 18 to 25 °C,
- relative air humidity of. 40 to 60% max,
- keep away from direct sunlight.

### Among impacts limiting the consistency of the printer are:

- long exposure to temperatures over 40 °C,
- being kept in a damp or humid environment,
- contact with softening materials (stored in PVC folio), with solvents, mollifiers, glues, with carbon and self-adhesive paper, direct sunlight.

When taping a report into an accounts book, only press tape at the end of the paper ribbon in order not to damage the printed data. If proper storage conditions are not maintained or non-quality journal paper is used, Elcom cannot guarantee the quality of printing.

If the red color stripe marking the ribbon end appears, change the paper ribbon immediately. Delay in changing the paper roll can damage the printer or possibly shorten its lifespan.

## USING A MEMORY CARD

The slot for the memory card is located in the space for the cash register battery (see Fig. 2.8). The Euro-50TE Mini cash register supports work with memory cards of the SD type up to a capacity of 2 GB (the Elcom company does not guarantee functionality of the cash register with cards of the micro and mind SD type). At present it is possible to use the memory card for the export and import PLU databases (see the chapter „Export and Import“).

*Warning: Open the battery cover only when the cash register is turned off.*

**Figure 2.8 – Installing an SD card into the cash register**

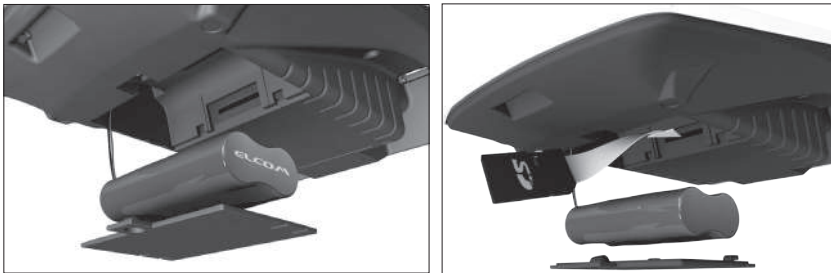

## Setting the display contrast :

At different light intensity it's possible to set the contrast of the displayed characters on the operator display of the cash register.







The contrast can be set in any cash register's mode by pressing the **SHIFT** and key **↑** to increase the contrast or **↓** to decrease the intensity of the contrast. The set of contrast level will be in use after switching OFF and ON again.

***PROGRAMMING  
THE CASH REGISTER***

## INITIALIZATION

Before putting the cash register into use for the first time, it is necessary to initialize it. Initialization of the cash register clears all programmed product items, departments, sales units, surcharges and discounts. All other settings and register counters are preserved.

### Procedure for initialization:

Sequence of steps	Display
Turn the cash register on and using the buttons  (MENU),  TOTAL and  or  enter into the initialization menu (Main menu – P-mode – Sys. parameter – Initialization)	Sys.Parameter Initialization
Press  TOTAL and then confirm the initialization by pressing the  SUBTOTAL button.	Continue? yes=ST, no=other
The cash register begins initialization and „Clearing...” appears on the display. After successful completion of initialization the display reads:	Clearing OK



## GENERAL PROCEDURE WHEN PROGRAMMING IN "P" MODE

Before you start programming the cash register, we recommend that you read this chapter at least one time through!

### Note:

**If a button has two functions, the function in the lower part of the button is selected by directly pushing the button; in order to select the upper function, it is necessary to first press the  (SHIFT) button.**







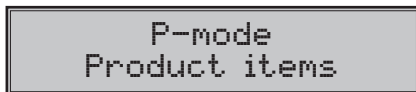

### Basic rules for navigating in a menu





- 1) Switch the cash register into the Main Menu by pressing the  (MENU) key and then use the arrow keys  or  to navigate to the P-mode menu





confirm your choice by pressing the  TOTAL (CELKOM). Na displeji sa objavi:





- 2) By pressing the arrow keys  or  you can navigate through the individual lines of the programming mode, which are described in more detail in the following chapter.
- 3) Press the  TOTAL key to enter into the selected item menu, or to confirm (save) a programmed value. Continue in this way until you have programmed all of the necessary parameters. Or press the  (MENU) key to switch to a menu one level higher (back).
- 4) After selection of a specific parameter, a value is set either by manually entering a numerical value (price, EAN,...), entering text on the keyboard (names of PLU, DPT, sales units,...) or by pressing the arrow keys  or . After setting a correct value, confirm it by pressing the  TOTAL, button; the newly programmed parameters is then printed out.
- 5) Should you make a mistake when entering a numerical value or text, you can remove the incorrectly entered character by pressing the  CLEAR button.

- 6) If there is no necessity to change (save) a given parameter, it is possible to pass to another item using the arrow keys  or  or to leave the given menu by pressing the  (MENU) button.
- 7) Complete the programming by pressing the  (MENU) button.

**TIP:** Press  or  to switch between equal parameters for individual items. For example, when programming the name of the first product item, after pressing  you automatically switch to programming the name of the second product item.

## Printing of programmed values

Print a value for a specific programmed parameter by pressing the  (EAN), key; print all parameters in a given item by pressing  SCALE and use the  VOID button to print out all active items in the given menu.

## Revision of programmed values

- 1) In order to change the setting of any parameter, switch the cash register into P-mode and find the relevant parameter in the menu.
- 2) Enter the new value and confirm by pressing the  TOTAL key.

**Note:**

**Proceed according to the chapter „ Basic rules for navigating in a menu“.**









**Warning:**

**Some parameters can be changed only after meeting the requirement for a change (for example a daily, monthly Z report, an exchange rate setting,...); conditions for a change will be presented along with the specific parameters.**

## Editing text in EditMode

EditMode function is for edit and add new text. It's started at text entry, right after entering new text, when the old content is deleted or by pressing the key , the old text will be not deleted, and the text could be changed.

In the EditMode, the following keys can be used:

-  – Enter/Cancel EditMode. Entering the EditMode is indicated with the cursor “\_”
-  – move cursor to left,
-  – move cursor to right,
-  – move cursor to left side of the line
-  – move cursor to right side of the line
-  – start/cancel input or change text (InsertMode). The input mode is identified with the sign “\_”
-  – start / cancel writing numbers (NumLock)
-  – delete whole line

**\* cursor is displayed on the end of the line, indicating actual position where the text will be changed or added.**

## Recommended procedure when programming the cash register

We recommend that when programming individual functions of the cash register that a user do so in the following order:

- 1) price and tax parameters
- 2) currencies (if you accept payment in a foreign currency)
- 3) taxation levels
- 4) receipt logo
- 5) departments
- 6) sales units

- 7) product items
- 8) surcharges and discounts
- 9) system parameters - Date and time
- 10) peripherals (if applicable)

**Table 3.1 - Structure of the menu in P-mode**

Mode	ABBR.*	Menu name	Menu description
P mode	1	Product items	Menu for programming of PLUs
	2	Departments	Programming the name of a DPT
	3	Cashiers	Programming parameters cashiers
	4	Tax levels	Menu for programming rates and types of taxes
	5	Text logo	In this menu you program the logo with data about your company
	6	Function text	Modification of functional text
	7	Sales units	Possibility of programming sales units
	8	Surcharges and discounts	Programming values and limits for surcharges and discounts
	9	Currencies	Settings for primary and secondary currencies
	-	Price and tax parameters	Setting parameters for prices, cash and taxes
	-	Graphic logo	Enabling printing of graphic logo
	-	Journal	Text journal settings
	-	Binary journal	Binary journal settings
	-	System parameters	Menu for systematically setting the cash register, Changeover to the euro
-	Peripherals	Setting for peripherals (scanner, scales)	

\* abbreviations are use for rapid navigation in the menu

**Example:** if you are in P-mode and press, for example, the number 4, you'll jump to the menu for programming the text logo.

## PRICE AND TAX PARAMETERS

**Note:**

**Prior to programming, read the „General procedure when programming in P mode“, which is located at the beginning of the chapter „Programming the cash register“.**

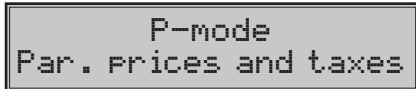

**Table 3.2 – Price and tax parameters - move through the menu using the arrow keys ← or →**

Menu	ABBR.*	Sub-menu name	Sub-menu description
Price and tax parameters	1	Settings for prices	Basic settings for prices
	2	Settings for cash	Basic settings for cash
	3	Settings for taxes	Basic settings for taxes

\* abbreviations are used for rapid navigation in the menu



These parameters are data which have a primary impact on the proper functioning of the entire cash register (number of decimal places, rounding off, etc.). Settings for all parameters, in accordance with applicable laws, are created after launching the cash register into operation.

## Overview of individual price and tax parameters

### Settings for prices

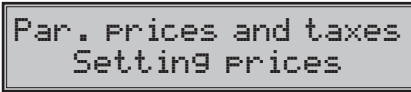

The table provides an overview of individual parameters for setting prices, including the range of possible values, basic settings and a brief description.

**Table 3.3 – Settings for prices – move through the menu using the arrow keys ← or →**

Name of parameter	Default settings	Range	Description
No. of places per price*	2	0-3	Setting the number of decimal places, unit price
Method or rounding.*	up from 5	down, up, up from 5, quarters, eighths	Method of rounding prices
Position of rounding	1	0-3	Position of rounding prices

\* method of editing – use the arrow keys ↑ or ↓

### Settings for cash

The table provides an overview of individual parameters for setting cash showing the range of possible values, default settings and a brief description.

**Table 3.4 – Settings for cash – move through the menu using the arrow keys ← or →**

Parameter name	Default setting	Range	Description
Primary currency - rounding.*	quarters	down, up, from 5 up, quarters, eighths	Method of rounding cash in primary currency
Primary currency- position of rounding	0	0-3	Parameter for position of rounding in primary currency
Secondary currency-rounding.*	from 5 up	down, up, from 5 up, quarters, eighths	Method of rounding cash in secondary currency
Secondary currency-position of rounding.*	2	0-3	Parameters for position of rounding in secondary currency

\* method of editing – use arrow keys ↑ or ↓

#### Note:

**For quarterly rounding (for 50 hollers and whole crowns) it is necessary to set the parameter „Main currency - position of rounding“ to the value of 0.**

### Settings for taxes

The table provides an overview of individual parameters for the settings for taxes showing the range of possible values, default settings and a brief description

**Table 3.5 – Settings for tax levels – move through the menu using the arrow keys ← or →**

Parameter name	Default settings	Range	Description
Method of rounding.*	from 5 up	down, up, from 5 up, quarters, eighths	Method of rounding taxes in the primary currency
Position of the rounding.*	1	0-3	Position where taxes should be rounded
Tax printing	yes	yes, no	Possibility to print taxes on the receipt

\* method of editing – use arrow keys ↑ or ↓

## CURRENCIES

**Note:**

**Prior to programming read as soon as possible the section „General procedure when programming in P-mode“, which is found at the start of the chapter „Programming the cash register“.**



The cash register allows you to accept payment in cash in a foreign currency as well. For this purpose there is a menu for setting currencies which contains the following parameters:

**Table 3.6 – Currencies –move through the menu using the arrow keys ← or →**

Parameter name	Default setting	Range	Description
Primary currency - name	EUR	3 characters	Programming the name of the primary currency
Primary currency - dec. places	2	0-3	Number of decimal places - primary currency
Secondary currency - name	USD	3 characters	Programming the name of the secondary currency
Secondary currency - exch. rate	33.5123		Exch. rate for secondary currency
Secondary currency - dec. places	2	0-3	Number of decimal places - secondary currency
Exchange rate	32.4531		Exchange rate for dual circulation

\* method of editing – use arrow keys ↑ or ↓

\*\* more information regarding dual circulation can be found in the chapter „Changeover to the euro“

**WARNING:**

**Some parameters can be programmed only after fulfilling certain conditions. For example, performing a daily Z report (a change in the exchange rate for the secondary currency), or performing a monthly report for other parameters. The exchange rate can be changed without having to perform one of the Z reports up to the start of dual circulation. With a change in the secondary (foreign) currency, calculations for the drawer will mix two currencies. Therefore, if this value is important for you, make the choice prior to the change in the secondary currency (see TIP in the chapter „Withdrawing of cash or checks“).**

## TAX LEVELS

**Note:**

**Prior to programming read as soon as possible the section „General procedure when programming in P-mode“, which is found at the start of the chapter „Programming the cash register“.**

## P-mode Taxation levels

The cash register allows you to work with up to 7 levels of taxes (VAT). The taxation rate and its type are programmable. The rate of taxation levels must be programmed in accordance with valid legislation.

### Notice:

For a change in taxation it is necessary to perform a Z daily and a Z monthly report. See the chapter „Reports“.

**Table 3.7 - parameters for programming of taxation rate**

Parameter	Default setting	Range	Description
TAX-rate	VAT1 = 19.00%, VAT2 = 10.00%, VAT7=non-taxable	0-100%	Setting of a taxation rate
TAX-type*	VAT	VAT	Non-taxable type of tax, characterizes, whether it involves a VAT or non-taxable level

\* method of editing – use arrow keys  or 

### Note:



**A tax level set to a value of 100% is inactive. A PLU assigned to an inactive taxation level cannot be registered.**

## TEXT LOGOS





### Note:

**Prior to programming read as soon as possible the section „General procedure when programming in P-mode“, which is found at the start of the chapter „Programming the cash register“.**

## P-mode Text logo

The cash register allows you to print up to 9 lines of company logo information (for example: „Mom and Pop’s Grocery Store, „Thank You“, and the like.) at the top of the receipts. Each line allows the printing of 18 characters of normal width or 9 of double width. Enter a double-width character by pressing   before pressing the character. On the display, the character „~“, will appear. This indicates that the following sign will be double-width.

```
1st line of logo
~E ~L ~C ~O ~M
```

For shifting between individual lines of logo text, use the arrow keys  or . For confirming (storing) changes in the contents of the logo lines press the  TOTAL button; to leave logo programming, press the  (MENU) button.



The cash register prints only lines of the text logo that contains characters (space is considered as a character). Empty lines are not printed. Erasing of line is done by pressing of the  TOTAL key.

## GRAPHIC LOGO

Programming of the graphic logo can be done by using the communication software available at [www.elcom.eu](http://www.elcom.eu) or with help of the Import function from SD card.

**Parameters of the graphic logo :**

- format bmp
- bit depth 1bit (without grayscale)
- maximum size of 360x240 pixels ( at lower pixel rate of the graphic logo, the logo is not stretched or completed to maximum size)

Print of the graphic logo can be set by pressing the   keys, after which the  TOTAL key has to be pressed. If the print of the graphic logo is set to YES and the logo was not programmed, graphic logo will be not printed on the receipt.

## **PROGRAMMING OPERATORS**

**Note:**

**Before start programming, read the chapter “Basic procedure at programming in P mode”, which is at start of the chapter “Programming ECR”.**



Set of the operator’s password allows operator to login to his account and this way enter different functions and modes of the cash register. After a cashier’s login, the name set for his account will be printed on the receipt and each operation made in time of his login will be recorded separately.

**Table 3.8 – parameters for programming cashier accounts**

Oper. name	Oper. password	Oper. X-mode	Oper. Z-mode	Oper. P-mode	Oper. T-mode
10 characters	4 characters	Yes	Yes	Yes	Yes
		No	No	No	No

**Note:**

**If any change was made for actual logged in account, to apply the changes, log out and login has to be done.**

## **DEPARTMENTS**

**Note:**

**Prior to programming read as soon as possible the section „General procedure when programming in P-mode“, which is found at the start of the chapter „Programming the cash register“.**

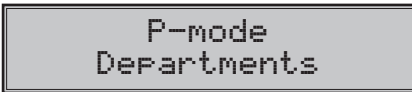

The Euro-50TE Mini cash register allows you to program up to 20 different departments (To see what constitutes a department and for an example, look in the introduction of this manual in the chapter „Basic Definitions“). A department can be programmed with a name up to 18 characters in length.

## **SALES UNITS**

**Note:**

**Prior to programming read as soon as possible the section „General procedure when programming in P-mode“, which is found at the start of the chapter „Programming the cash register“.**

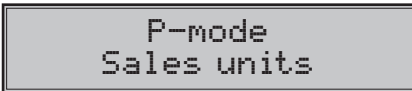

For each PLU it is possible to assign a sales unit which characterizes the specific product. It is possible to program 8 sales units to a maximum of 3 characters for each.

**Table 3.9 - basic preprogrammed sales units**

Unit, number	Description	Unit, number	Description
1		5	m
2	ks	6	m2
3	kg	7	btl
4	l	8	pac

## FUNCTION TEXT

With this function, the value of the function text "Reference number", displayed at entering the reference text can be changed. After edit this text, the value is set by pressing the key  TOTAL (CELKOM). After deleting the text, an empty line will be printed. The row has 24 characters or 12 double size characters

## PRODUCT ITEMS

### Note:



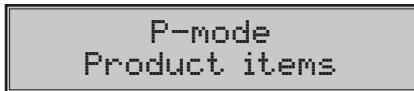

**Prior to programming read as soon as possible the section „General procedure when programming in P-mode“, which is found at the start of the chapter „Programming the cash register“.**







The Euro-50TE Mini cash register offers the opportunity to program 2000 PLUs. For each product item it is possible to program the following:

**Table 3.10 – parameters for programming product items**

Parameter	Default settings	Range	Description
PLU-price	0.00	max. 8 digits	Programmed price of the product
PLU-name		max. 18 characters	Name of the product
PLU-no. code*	0000000000000	max. 18 digits	Item bar-code number
PLU-attribute.**	0101010000100		Attribute of the item
PLU-tax rate***	19.00		Assigned tax level
PLU-DPT***	DPT01		Assign to a department
PLU-unit.***			Assign to a sales unit
PLU-linkPLU****	0000	0-2000	PLU number which is linked
PLU-other price***	yes	yes, no	Possibility for entering another price other than programmed
PLU-descriptive***	no	yes, no	Attribute if a descriptive item is involved. In this case print out a name PLU but sale doesn't impact financial count.
PLU-refundable packaging***	no	yes, no	Attribute for assigning item to a category of returnable packaging (bottle, crate, barrel,...).

- \* a bar code can be entered manually, or also with the help of a bar-code scanner
- \*\* to program the attributes of product items, press the button  TOTAL, or enter the attribute manually for the given PLU and confirm the change with the  TOTAL button. When you want to switch out of the programming attributes, press the  button.
- \*\*\* method of editing – use arrow keys  or 
- \*\*\*\* linking PLUs is used if with a sale of one PLU (the master PLU) we want to sell another PLU/linked; for example, this can be used with different activities, buy PLU1 and you get PLU5 for the price of X, or in the case of a refundable package (bottle, crate, ...) As a value, the PLU number is entered in the range of 1-2000; with the setting for a value of 0 to the product item, no PLU is linked. It is not possible to link a PLU with itself!

**Note: A product item without a name or assigned to an inactive taxation level is inactive (it cannot be registered).**  
**TIP: By pressing  or  you can shift between equal parameters for individual items. For example, when programming the name of the first product item, after pressing  you are automatically shifted to programming the name of the next product item. When programming prices of items the buttons  PRICE, function in a similar way, that is, when programming the price for the first product, press the PRICE button and you'll automatically shift to programming the price of the second item.**

## Jumping to a specific product item

If we want to change a parameter, for example, for the 25th PLU item, this can be done as follows:

Sequence of steps	Display
Set the cash register to the P-mode for programming product items; the setting of a price for the first product item is displayed:	0001.PLU-price 0.00
Enter the number of the item you wish to jump to; in our case the 25th, and press the button  (PLU)	0001.PLU-price 25
Cash register jumps to the programmed price for the PLU no. 25	0025.PLU-price 0.00

## SURCHARGES AND DISCOUNTS

**Note:**

**Prior to programming read as soon as possible the section „General procedure when programming in P-mode“, which is found at the start of the chapter „Programming the cash register“.**

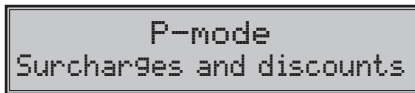

**Table 3.11 – parameters for programming surcharges and discounts.**

Parameter name	Default setting	Range	Description
1.rate % surcharge	0,00	0,00-100%	Programmed value of percent surcharge
2.limit % surcharge	0,00	0,00-100%	Limit for manual entry of surcharge during sale
3.rate % discount	0,00	0,00-100%	Programmed value of percent discount
4.limit % discount	0,00	0,00-100%	Limit for manual entry of discount during sale

Parameter "Limit percentage surcharge and percentage discount" set the limit for value discount and surcharge. That means if you wish to deny use of value discount/surcharge, the value for percentage discount/surcharge has to be set to "0".

## SYSTEM PARAMETERS

### Note:

Prior to programming read as soon as possible the section „General procedure when programming in P-mode“, which is found at the start of the chapter „Programming the cash register“.

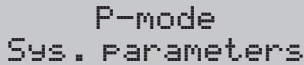

P-mode  
Sys. Parameters

Table 3.12 – System parameters - move through the using the arrow keys  or 

Menu	ABBR.*	Name of sub-menu	Description of sub-menu
System parameters	1	Power-saving mode	Setting the time for transfer to power-saving mode (0-60 min)
	2	Date and Time	Programming the date and time
	3	Tests	Basic cash register tests
	4	Initialization **	Clears all programmed data and returns register to default settings
	5	Changeover to the euro	Switching on and off of dual display, dual circulation (see chapter „Changeover to the Euro“)
	6	Software version	Cash register displays actual version of software in the register. Press  (EAN) to print out the version number.
	7	Export	Export PLUs (all programmed data) to a memory card
	8	Import	Imports PLUs from a memory card

\* abbreviations are used for rapid navigation in the menu

\*\* more information in the chapter „Initialization“.

## Exporting and Importing of data

### Exporting of data

The „Export“ function serves for the storing of data from the cash register to an SD memory card (not included with the cash register). This function can be used for the backing up of product items, or in the case of a software upgrade, for backing up and subsequently renewing data.

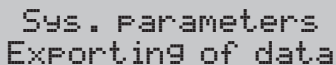

Sys. Parameters  
Exporting of data

You can, if you wish, backup only product items (PLU), or all data (DPT, Sales units, PLU, Surcharges and discounts, Taxation levels, Text logos)

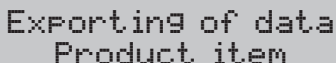

Exporting of data  
Product item



Export  
All

When the export of PLUs is successful, a „PLU.EDF“ file containing all the PLUs is created on the memory card. The file can be edited in the „Euro-50 PLU Editor“ program, which you can download from our Web site, [www.elcom.eu](http://www.elcom.eu). After saving changes to the file using the same name, „PLU.EDF“ you can then import the data back to the cash register.

When you choose the option Export-All, the following files are created on the memory card:

- DPT. EDF - departments
- FUNCTEXT.EDF - function texts
- LOGO.BMP - graphic logo

- MEASUNIT.EDF – sales units
- OPERATOR.EDF - cashiers
- PLU.EDF – product items
- SURDISC.EDF – add-ons and discounts
- TAXGROUP.EDF – taxation levels
- TEXTLOGO.EDF – text logo

**Warning:**

Until stored data from the cash register has been stored to a memory card, further exporting will cause it to be overwritten and irrevocably lost.

**Importing of data**

The „Import“ function serves for pulling data from the SD memory card to the cash register memory. You can use this function to renew PLUs, for example, in the case of an upgrade of the cash register software.



In the first version, it is possible to import only product items (PLUs).



For successful import of PLUs, the file „PLU.EDF“, which contains PLUs and was created by an export from the cash register, must be on the memory card, or alternatively, import can be performed with the help of the „Euro-50 PLU Editor“ program, which you can download from our Web site at [www.elcom.eu](http://www.elcom.eu).

**Warning:**

- When importing, all PLUs stored in the cash register will be overwritten with PLUs from the SD memory card and will be irrevocably lost.
- During an export or import of cash register data, do not shut off the register and do not remove its battery cover!
- For correct import of function, the name of the file has to be correct with the data, that has to be like mentioned above.

**PERIPHERALS**

**Note:**

*Prior to programming read as soon as possible the section „General procedure when programming in P-mode“, which is found at the start of the chapter „Programming the cash register“.*

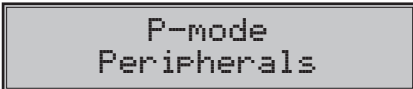

In this menu you can configure the parameters for peripheral attachments such as a bar-code scanner and an electronic scale.

**Table 3.13 – Peripherals - move through the menu using the arrow keys  or **

Menu	Abbrev.	Name of sub-menu	Description of sub-menu
Peripherals	1	Scanner	Parameters and communications port for communicating with a scanner



	2	Scale	Parameters and communications port for communicating with scales
	3	Payment terminal	Parameters and communications port for payment terminal
	4	PC	Parameters and communications port for PC

\* abbreviations are used for rapid navigation in the menu

**Table 3.14 - parameters for programming a scanner**

Parameter	Default setting	Range	Description
Terminal code*	CR LF	CR LF, CR, LF	Terminal code for bar-code scanner
Communication port	none	none, Port 1, Port 2	Communication port for bar-code scanner

\* method of editing – use arrow keys  or 

**Table 3.15 - parameters for programming the scale**

Parameter	Default settings	Range	Description
Type of scale *	Morcan, MARTES T	Morcan, MARTES T, Euro, MARTES M, Macca K, DIBAL, Motex R, Mettler Toledo, ACOM, CAS Morcan TP2	Communication protocol for electronic scales
Communication port *	none	none, Port 1, Port 2	Communication protocol for an electronic scale

\* method of editing – use arrow keys  or 

**Table 3.16 – parameters for programming of the payment terminal**

Parameter	Default setting	Valid values	Description
Type of the payment terminal	Bull SK	Dionica SK SLSP, Bull SK, Firstdata I5100	Communication protocol of the payment terminal
Communication port	none	none, Port 1, Port 2	Communication port for payment terminal

\* to edit values use the  or 

**Table 3.17 – parameters for programming the PC port**

Parameter	Default setting	Valid values	Description
PC port	USB port	USB none	Communication port with the PC

## Text journal

The control tape is stored in electronic journal. The journal is temporary stored in the internal memory of the cash register. The content of the internal memory can be exported on the memory card or transfer to PC through the communication cable and the communication software. After the successful transfer, the electronic journal will be deleted from the cash register. Automatic export of the electronic journal on the memory card (memory card is not included) at daily report, simplifies the work with the electronic journal.

**Table 3.18 – Parameters of the text journal – enter the menu with the keys  or **

Menu	Abbr.*	Name of sub menu	Description of the sub menu
Journal	1	Print of journal	Print the journal on the tape
	2	Export on SD card	Save the journal on the memory card
	3	Delete the journal	Delete the journal after printing or export
	4	Size of the journal	Display left space for journal in %
	5	Settings	Allow to set automatic export of the journal after daily "Z" report.

## Binary journal

Store structured information about sales. This data can be transferred to PC and provide information for different sale statistics.

**Table 3.19 – Binary journal**

Menu	Abbr.*	Name of sub menu	Description of the sub menu
Binary journal	1	Export on SD card	Save the journal on the memory card
	2	Delete the journal	Delete the journal after printing or export
	3	Size of the journal	Display left space for journal in %
	4	Settings	Allow to set automatic export of the binary journal after daily "Z" report.

## CHANGEOVER TO THE EURO

**Note:**

*Prior to programming read as soon as possible the section „General procedure when programming in P-mode“, which is found at the start of the chapter „Programming the cash register“.*

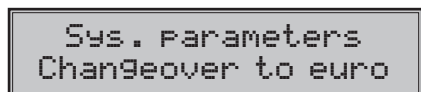

Prior to devoting your time to this chapter, please read the chapter „Concepts defining the launch of the euro currency or payment in a foreign currency“.

The Euro-50TE Mini cash register is capable of working with a primary, a foreign (secondary) and dual currencies according to which stage is in effect.

**Notice:**

It is possible to change the parameters for a foreign currency after performance of a monthly "Z" report and the exchange rate after performing a daily "Z" report.

**Table 3.20 – Changeover to the euro - move through the menu using the arrow keys  or **

Menu	Abbr.*	Name of the sub-menu	Description of the sub-menu
Changeover to the euro	1	Start of dual display**	Switching on of dual display
	2	Start of dual circulation***	Switching on of dual circulation
	3	End of dual circulation	Switching off of dual circulation
	4	End of dual display	Switching off dual display

- \* abbreviations are used for rapid navigation in the menu
- \*\* the switching on of dual display is a conditional on the assigning (checking) of a conversion rate
- \*\*\* the switching on of dual circulation is conditional on switching on of dual display





## Stage prior to announcing of the conversion rate

The cash register works with the primary currency, which is the Slovak crown, but it can also work with a foreign (secondary) currency, which can be an optional foreign currency, including the euro. To do this it is necessary to set (or modify) the preset parameters in the „Currencies“ menu, according to the most recent data (exchange rate for the secondary currency). You'll find the procedure for registering and using the secondary currency in the chapter „Registration using the euro currency“.

## Dual display

This period lasts from the announcement of the fixed conversion rate until the start of the changeover to the euro. The cash register works with two currencies. The primary currency is the Slovak crown, the secondary currency is the euro. Dual currency serves as an informational depiction of prices for purchases for the needs of dual display calculation with the help of the exchange rate.

The procedure for switching on dual display:

Sequence of steps	Display
In P-mode enter use the  or  buttons and press  TOTAL to enter the changeover to the euro menu (P-mode – Sys. parameter – Changeover to euro):	Changeover to euro Dual displ. start
Confirm by pressing  TOTAL; text is printed on the receipt: „Dual display ready“, we then recommend checking the settings of these parameters in the „Currencies“ and „Price and Tax Parameters – Settings for cash“ menu:	Warning Configuring

Currencies
Currencies - Secondary currency-name – must be EUR, so long as a secondary currency is used in dual display
Currencies - Secondary currency-decimal places - we recommend setting for 2 places
Currencies - Conversion rate – change according to the actual rate announced
Parameters for prices and taxes – Settings for cash
Settings for cash – Primary currency-rounding - we recommend quarterly
Settings for cash – Primary currency-position of rounding - we recommend setting it to 0
Settings for cash – Secondary currency-rounding. - we recommend from 5 up
Settings for cash – Secondary currency-position of rounding - we recommend setting for two places

**Note:**

**The minimal required condition for switching on dual display of prices is the setting (or checking) of the exchange rate.**

**Notice:**

The operator of the cash register is responsible for the correct entering of the exchange rate; therefore it is necessary to strictly check that the rate is correctly entered.

Sequence of steps	Displej obsluhy
After setting or checking of these parameters it is essential to again go to the menu for switching on dual display and confirming its activation with the button  TOTAL	Changeover to the euro Dual disp.l. start
Printed on the receipts is „Dual display: switched on“	Step was successful performed

From this point on, all receipts will show the purchase price in euro as well. The value in EUR is calculated using the conversion rate. This data is for informational purposes only.

**Note:**

**Dual display cannot, according to the law on the introduction of the euro, be switched on prior to the announcement of the fixed conversion rate and cannot be switched off during the period of mandatory dual display of prices.**

## Dual circulation

With the changeover to dual circulation the values of GT1, GT2 and GT3 will be automatically calculated according to the conversion rate. We then recommend that you perform an informational „X“ daily report.

**Warning:**

The value of the calculation for the drawer is cleared. Therefore, if this value is important to you, prior to the changeover to dual circulation, make a withdrawal (see chapter „Withdrawing cash or checks“).







This is the stage of gradual withdrawal of the Slovak crown from circulation, which will last for 16 days. During this stage mandatory dual display of prices still applies. The cash register operates with two currencies. The primary currency is the euro, with the Slovak crown as the secondary currency.

The setting of implicit parameters meets the requirements of the law on the introduction of the euro currency and other associated laws and regulations. We recommend that you consult with an expert on the change of these standard settings.

**The requirements of laws and regulations are in particular:**

- a) the rounding of sale (final) prices of items, taxes and total purchase sums should be performed for 2 decimal places; that is, rounding should be done for 1 eurocent to 0.5 cents in the down direction and from 0.5 cents inclusive in the upwards direction.
- b) unit prices of items may be during the phase of mandatory dual pricing depicted after the changeover to the euro to 3 decimal places, even if the third valid decimal place is a 0.

Process of the changeover:

Sequence of steps	Displej obsluhy
Performing all Z reports which the cash register allows (see user manual section Reports).	
In P-mode press  or  and the button  TOTAL to enter the menu for changeover to the euro (P-mode – Sys. parameters – Changeover to euro) and with the arrow keys  or  set:	Prechod na euro Duál.obeh.štart
Confirm with the button  TOTAL; on the receipt the text will appear: „Dual circulation: ready“. We then recommend checking the settings on the „Currencies“ and „Price and tax parameters“ menus:	Upozornenie Uskutoč.konfig.

Currencies
Currencies- Primary currency-name - EUR
Currencies- Primary currency-decimal places - 2 decimal places
Currencies- Secondary currency - name - SKK
Currencies-Secondary currency - exchange rate - according to the actual announced conversion rate
Currencies- Secondary currency - decimal places - 2 decimal places
Currencies- Conversion rate -according to the actual announced conversion rate
Price and tax parameters - Settings for prices
Settings for prices - No. of sales units prices - we recommend 3
Settings for prices - Method of rounding - we recommend up from 5
Settings for prices - Position of rounding. - we recommend 2 decimal places

Price and tax parameters - Settings for cash
Settings for cash - Primary currency-rounding. - we recommend down from 5
Settings for cash - Primary currency-position of rounding - we recommend for 2 decimal places
Settings for cash - Secondary currency -rounding. - we recommend quarterly
Settings for cash - Secondary currency-position of rounding - we recommend 0 places
Par. for prices and taxes - Settings for taxes
Settings for taxes - Method of rounding - we recommend up from 5
Settings for taxes -Position of rounding - we recommend for 2 decimal places

Sequence of steps	Displej obsluhy
After setting or checking, it is necessary to again go to the menu for switching on dual circulation and confirm by pressing the button  TOTAL.	Changeover to euro Start of dual circ.
The text „Dual circulation: on“ will be printed out. Performing the changeover involves setting of the primary currency to the EUR, and foreign currency to SKK	Step was successfully performed

**Calculating prices of items from SKK to EUR:** During the changeover no price change occurs to PLUs, therefore for prices used in the euro currency it will be necessary to change the original price in Slovak crowns into euros with the help of the exchange rate according to the rules defined in the law on the introduction of the euro currency!







**WARNING:**

- In dual cash circulation it is not possible to change the exchange rate! The conversion rate becomes the exchange rate.
- The conversion rate cannot be changed after entry to dual cash circulation!
- In dual cash circulation it is not possible to pay in another foreign currency other than SKK. It is only possible to pay for goods in EUR and SKK.

## The end of dual circulation

After the end of dual cash circulation it is possible to set another foreign currency in the cash register in place of SKK. The parameters of this currency must be programmed into the „Currencies“ menu, (see the Currencies section). For the use of another foreign currency it is not necessary to end dual display of prices.







Process for turning off dual circulation:

Sequence of steps	Display
In P-mode enter using the  , or  and the button  TOTAL the menu for changeover to the euro (P-mode – Sys. parameters – Changeover to euro) and with the arrow keys  , or  set:	Changeover to the euro Stop of dual circ.
Confirm with the button  TOTAL, on the receipt text will appear: „Dual circulation: switched off“. Now it is possible to select a secondary currency other than SKK; once dual circulation is ended it is not possible to accept payment in SKK.	Step was successfully performed

## The end of dual display

The obligation for dual display of prices lasts by law until the end of 2009.

Procedure for switching off dual display:

Sequence of steps	Display
In P-mode enter using the keys  , or  and the button  TOTAL button the menu for changeover to the euro (P-mode – Sys. parameters – Changeover to euro) and with the arrow keys  , or  set:	Prechod na euro Duál.zobr.stof
Confirm with the button  TOTAL on the receipt text will appear: „Dual circulation: switched off“. Now it is possible to select a secondary currency other than SKK; once dual circulation is ended it is not possible to accept payment in SKK.	Step was successfully performed

***OPERATION  
IN REGISTRATION MODE***

The functions that are described in the following chapters are used in the registration mode.

All financial transactions are stored when working in this mode. The following functions can first be tried out in the training mode (sales data are not stored in the memory).



## **STATUS AND FUNCTIONS WHICH ARE REQUIRED TO KNOW PRIOR TO THE START OF RINGING SALES**

If there are two functions on a key, the function in the lower part of the button is selected by simply pressing the button. To select the upper function, you must first press and hold the  (SHIFT) key.

### **Error warning - the CLEAR key**

With the incorrect use of a function key, or if the range of the display is exceeded, an error message appears. The description of the error can be removed by pressing the  CLEAR key. Afterwards simply enter the correct information.

### **Keys for finalising payment with CASH, CHECK and CREDIT**

All business transactions are completed by pressing certain keys determined for payment, or a combination of keys. Depending on the method of payment (in cash, with a credit card, check, etc.) a transaction is completed by pressing the relevant keys:  TOTAL (CASH),  (CREDIT), or  (CHECK).





Prior to pressing the key for determining payment, it is possible to enter a value which the customer wants to pay towards the given payment. So long as the value entered is smaller than the required sum, the cash register will then request the payment of the remaining sum (possibility of combining individual payments); otherwise the cash register shows the sum which needs to be entered.

With payment by credit card or check, neither the payment nor the value of the sale is rounded.



#### **Note:**

*The subtotal commonly appears in its unrounded form.*





### **Cashier login**

At login of the operator, the account has to be chosen with help of the  . After choosing the cashier, the confirmation of the account is done by pressing the key  TOTAL. After that the cash register will require enter the login password. The password is confirmed with the key  TOTAL and after successful login, the cash register will enter the registering mode. If incorrect login information is entered, the cash register will inform the operator about this fact.

### **Switch operator**

This is done by log off of the cashier and login with other login information. The log off operation is done by pressing the key combination   SHIFT MENU until the message "Logged off ... " will be displayed. After that, the login procedure will follow, that is described in the precedent paragraph. The log off operation can be done only if more than one operator password was set.

## **REGISTRATION MODE MENU**

This menu is reached when in the registration mode (the sales mode) by pressing  (MENU). Pressing  or  will shift you through the individual menu items, which are described in detail in Table 4.1 and in the following chapters. By pressing  TOTAL; you enter into the selected menu item, or perform a cash register function.



**Table 4.1 – Structure of the menu in the registration mode**

Mode	ABBR.*	Menu name	Menu description
Registration mode	1	Sales	Sales mode
	2	Deposit cash	Deposit cash, for example, at the start of the day
	3	Withdraw cash/check	Withdraw cash, or checks
	4	Refund	Product refund

\* abbreviations are used for rapid navigation in a menu

## EXAMPLES OF BASIC ACCOUNTING PROCEDURES

Notice :

Try out accounting is done in T mode. If you wish to erase the GT value (incremented only in R mode), service intervention is required.

- 1) Login with password is required
- 2) Switch the cash register into registration mode „R“ (training mode „T“)
- 3) Enter the code of the item sold
- 4) Press the **PLU** (PLU) key
- 5) Repeat points 2 and 3 for each item you wish to ring in
- 6) Once you have rung in all items, press the **ST** (SUBTOTAL) key. The total amount of the sale, including tax, appears on the display
- 7) Announce the sum to the customer
- 8) Enter the sum the customer gives you and press the appropriate payment type key: **TL** (TOTAL (CASH)), **SHIFT CR** (CREDIT), or **SHIFT CH** (CHECK)
- 9) The amount necessary to return to the customer appears on the display; if the requested sum was smaller than the sum received
- 10) Tear off the receipt and give it to the customer along with any change.

**Figure 4.1 – Sample receipt:**

- 1 – receipt heading (logo),
- 2 – register ID information, owner of the operation
- 3 – date,
- 4 – time,
- 5 – cash register no. and receipt no.,
- 6 – cashier name,
- 7 – item name,
- 8 – tax level assigned,
- 9 – amount sold and unit price,
- 10 - sales price for the item

1	ABC GROCERIES Main Street 3 080 01 Prešov BIN: 1222345		
2	VAT ID: SK20200123 DKP: 72420200123450 Thank you G O O D B Y E		
7	Milk		
9	1x17.90	=17.90A	8
	Yosurt		
	1x8.90	=8.90A	10
	Mars		
	1x22.70	=22.70A	
	Soap		
	5x12.30	=61.50A	
	Subtotal	111.00	
	-----		
	Total	111.00	
	Cash	111.00	
	-----		
	Taxable A	111.00	
	NETTO A	93.30	
	VAT A 19.00%	17.70	
	Sale total	111.00	
	Netto total	93.30	
	VAT total	17.70	
	-----		
3	16-01-2008	12:08	4
5	01-0003	Cashier1	6

## PLU REGISTRATION

Each product item is assigned a number (a PLU number), for example, RAMA butter-5, whole milk-23, Rum-189, etc. Individual PLU numbers are programmed with information about the product - name, price, DPT, etc. Entering a PLU number and pressing **PLU** (PLU) automatically calls up and rings up the product from the cash register's database.

PLU registration allows the recording of the sale of individual items. The names of the items are taken from the cash register memory and printed on the receipt and the transaction is recorded in the department.

PLU selling reduces errors when ringing in sales, lists each item individually on the receipt, clearly organizes the sale and increases the speed of registering. This method of selling gives you an overview of the sale of each individual item.

### Basic PLU registration

**Example:** A customer buy Cheese Encian with a price of 7.00 and Butter Flora priced at 10.00:

Sequence of steps	Display	Receipt
<b>POS 1</b> <b>PLU</b>	1*Cheese Encian 7.00	Cheese Encian 1*7.00 =7.00A
<b>POS 2</b> <b>PLU</b>	1*Butter Flora 10.00	Butter Flora 1*10.00 =10.00A Subtotal 17.00
<b>ST</b> <small>SUBTOTAL</small>	Subtotal 17.00 EUR	T total 17.00 Cash 58.00
<b>TL</b> <small>TOTAL</small>	Cash 17.00 EUR	Taxable A 17.00 Netto A 14.30 VAT A 19.00% 2.70 Sale total 17.00 Netto total 14.30 VAT total 2.70

### Repeated registration of an item

**Example:** A customer buys one package of cheese (PLU 1: Cheese Encian with a price of 7.00), which is rung in, and then decides to buy a second package of cheese:

Sequence of steps	Display	Receipt
<b>POS 1</b> <b>PLU</b>	1*Cheese Encian 7.00	Cheese Encian 1*7.00 =7.00A
<b>PLU</b>	1*Cheese Encian 2 7.00	Cheese Encian 1*7.00 =7.00A Subtotal 14.00
<b>ST</b> <small>SUBTOTAL</small>	Subtotal 14.00 EUR	T total 14.00 Cash 14.00
<b>TL</b> <small>TOTAL</small>	Cash 14.00 EUR	Taxable A 14.00 Netto A 11.80 VAT A 19.00% 2.20 Sale total 14.00 Netto total 11.80 VAT total 2.20

## Multiplication in PLU registration

**Example:** A customer buys 12 units of Cheese Encian (PLU no. 1) with the programmed price of 7.00 Eur.

Sequence of steps	Display	Receipt
POK 1 TUV 2 / *	12*	Cheese Encian 12*7.00 =84.00A
POK 1 PLU	12*Cheese Encian 84.00	

## PLU registration using a price not programmed

The cash register can be programmed such that for registering with PLUs it is possible to use a price already programmed in or one entered via the keyboard (see the chapter Programming the Cash Register – Product Items). A customer gets a special price, but the given PLU already has a price programmed in. In the following example, PLU no. 2 has a programmed price of 31.20, but the sale price is 28.50 Eur.

Sequence of steps	Display	Receipt
TUV 2 ABC 8 - B . JKL 5 R1+ 0 PRICE	PRICE 28.50	Butter Flora 1*28.50 28.50A
TUV 2 PLU	1* Butter Flora 28.50	

## Multiplication in PLU registration using a price not programmed

**Example:** A customer buys 10 packages of Cheese Encian (PLU no. 1 with a price of 27.00 EUR). With this number of units, he gets a special sale price of 25.000 EUR entered at the cash register. (You can multiply a unit price also by fractional numbers (1.5; 0.125; etc.). The multiplier with the decimal part is used for direct sale of weighed goods (meat, vegetables, salads, and the like), where the unit price is determined (for example, per 1 kg, per 100g, etc.).

Sequence of steps	Display	Receipt
POK 1 TUV 2 / *	12*	Cheese Encian 12*25.00 =300.00A
TUV 2 JKL 5 - B . R1+ 0 PRICE	Price 25.00	
POK 1 PLU	12* Cheese Encian 300.00	

## Double multiplication in PLU registering

**Example:** The price programmed in for a square meter of carpet is 18.00 Eur (sample PLU no. 3 – Carpet). The customer purchases 3x5 square metres.

Sequence of steps	Display	Receipt
WXYZ 3 / * JKL 5 / *	3*5*	Carpet 3,5*18.00 =270.00A
WXYZ 3 PLU	3*5* Carpet 270.00	

It is possible to also use manual price entry; the process was presented in the chapter „PLU registration with a price not programmed“.

## Fractional PLU registration

**Example:** A price is set for package containing 5 units. The customer buys only 3 of them. Procedure:

Sequence of steps	Display	Receipt
	3/5*	
	3/5*bulb 40W 7.20	

It is possible to also use manual price entry; the process was presented in the chapter „PLU registration with a price not programmed“.

## OTHER TYPES OF PLU SALES

### Linked PLUs registration

If the PLU being sold has a different item linked to it (package, crate, sale product,...), the cash register automatically continues with the sale of the linked PLU item. (see the chapter Programming the cash register - Product items).

#### Applicable rules for registering of linked PLUs:

- The voiding of the main PLU automatically cancels the linked PLU
- With the refunding of the main PLU, a refund of the linked PLU is automatically registered.
- The linked PLU is registered in the same quantity as the main PLU.
- Registering of a surcharge/discount to the main PLU is not applied to the linked PLU, but only to the main PLU
- The price of the main PLU entered at the keyboard is not valid for the linked PLU.

### Registering of refundable packaging

When programming a refundable package it is necessary to set the relative attribute (PLU-ref. pack. – yes). For more, see the chapter Programming the cash register –Product items. Subsequently, it is possible to link a given product item to another PLU.

**Example:** A customer buys Beer Heineken (PLU no. 4 with a price of 6.00 Eur), and PLU no. 4 is further linked with PLU no. 100 (Bottle with a price of 0.30 Eur).

Sequence of steps	Display	Receipt
	1*Bottle 0.30	
	Subtotal 6.30 EUR	
	Cash 6.50 EUR	

**Note:**

*In the first step, for a brief moment, there is shown on the display information about the sale of beer, quickly information about the sale of the linked PLU is then shown (bottle).*

## Registration using bar codes

- a sale using a bar-code scanner

A bar-code scanning device can be connected to the cash register. The sale of a product using this scanner consists of simply scanning the bar code on the item's packaging. For proper functioning of the bar-code scanner with the cash register it is necessary to program the parameters of the scanner into the cash register (see Programming the cash register – Peripherals).

**Example:** The sale of 3 identical items using the bar-code scanner.

Sequence of steps	Display	Receipt
	3*	
scanning of a bar code	3* Butter Flora 33.00	

### Note:

A bar code must be programmed for the given PLU.

- sale of a product by manually entering the bar code

If necessary, when the bar-code scanner is not functioning or the bar code of an item cannot be read by the scanner, it is possible to manually enter the bar-code number directly into the register using the keyboard.

**Example 1:** The sale of a single product with the bar code 8586001760096

Sequence of steps	Display	Receipt
	8586001760096	
	1* Beer Heineken 6.00	

**Example 2:** The sale of 5 units of a product using the bar code 8586001760096.

Sequence of steps	Display	Receipt
	5*	
	5* 8586001760096	
	5* Beer Heineken 30.00	

## Entering amounts using electronic scales

The Euro-50TE Mini is capable of reading the weight of products from a connected electronic scale. Communication with a scale is possible only in the „R“ or „T“ modes. An electronic scale is connected to the cash register through a port which was set in the menu „Peripherals - Scales“.

After initiating communication (reading the weight) with the electronic scale by pressing the button SCALE the weight of the product being weighed can be changed (add or remove products) so long as the no other key has been pressed on the keyboard. After the cash register has read the weight of the goods, simply entering the PLU and press the (PLU) key. If the weight on the scale is stable or is a negative or zero, the product cannot be registered.

**Example:** The sale of product no. 21 (PLU 21) with a weight of 0.253 kg read from the electronic scale.

Sequence of steps	Display	Receipt
(reading weight from the elec. scale)	Weighing... 0.253	
	0.253*Orange 8.00	

For proper functioning of the electronic scale connected to the register, it is necessary to program the type of scale into the cash register (see the chapter „Peripherals - Scales“).

Your local cash register supplier can inform you about the possibilities of connecting specific types of electronic scales.

## CORRECTIONS AND VOIDS

### Clearing

**Example:** You entered an incorrect price which has still not been printed out. In the following example, number 1230 was entered erroneously in place of the correct number 1290.

Postupnosť krokov	Displej obsluhy
	1230
	16-01-2008 R 14:57:50
	1290

### Voiding (cancellations)

The void (cancellation) function is used only to correct a sold item in one specific, still unfinished sale. An example of use: During a sale we accidentally ring in a bad PLU or the customer rethinks the purchase of the given item.

- Voiding of the last registered item - a direct void.

Procedure: you sold the items Cheese Encian and Butter Flora, but you want to remove the butter and complete the purchase:

Sequence of steps	Display	Receipt
	1*Cheese Encian 7.00	
	1*Butter Flora 10.00	
	Void -10.00	
	Cash 7.00 EUR	

- Voiding of one of the previous items registered (not the last item registered) - an indirect void.

Procedure: If you want to void in a purchase one of the previously registered items (not the most recent, however), it is necessary to use the arrow keys  $\uparrow$  or  $\downarrow$  to skim through the record of items sold, afterwards press  $\text{RF} \text{ 5}$  (VOID).

**Example:** you sold Cheese Encian and Butter Flora and then you want to void the Cheese Encian from the sale:

Sequence of steps	Display	Receipt
$\text{POS} \text{ 1} \text{ PLU}$	1*Cheese Encian 1 27.00	 <p>Cheese Encian 1*7.00 =7.00 A Butter Flora 1*10.00 =10.00 A Void Cheese Encian 1*7.00 =-7.00 A ----- Total 10.00 Cash 10.00</p>
$\text{TIV} \text{ 2} \text{ PLU}$	1*Butter Flora 1 31.20	
$\uparrow$	1*Butter Flora (2) 31.20	
$\uparrow$	1* Cheese Encian (1) 27.00	
$\text{RF} \text{ 5}$	Void -27.00	
$\text{TL} \text{ TOTAL}$	Cash 31.00 EUR	

**Note:**

The number in parenthesis tells you the line number of the item in purchase

- Voiding (annulling) an entire receipt

Procedure: If you wish to void an entire receipt, proceed as follows:

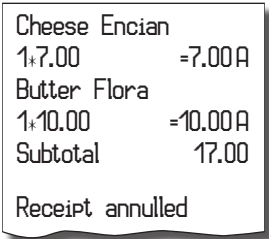
Sequence of steps	Display	Receipt
$\text{POS} \text{ 1} \text{ PLU}$	1*Cheese Encian 7.00	 <p>Cheese Encian 1*7.00 =7.00 A Butter Flora 1*10.00 =10.00 A Subtotal 17.00  Receipt annulled</p>
$\text{TIV} \text{ 2} \text{ PLU}$	1*Butter Flora 10.00	
$\text{ST} \text{ SUBTOTAL}$	Subtotal 17.00 EUR	
$\text{RF} \text{ 5}$	Annulling of the receipt -58.20	

## SURCHARGES AND DISCOUNTS



### Percent surcharge/discount on an item

The cash register allows you to program a percentage rate that is used for a surcharge with they key  $\text{€} \text{ %} \text{ +}$  (PERCENT SURCHARGE) and for a discount with the key  $\text{€} \text{ %} \text{ -}$  (PERCENT DISCOUNT) and also limits for manual entry of discounts or surcharges. If you need to register a rate different than the one that is pre-programmed, enter the numeric value of the surcharge or of the discount before pressing the  $\text{€} \text{ %} \text{ +}$  PERCENT SURCHARGE), or  $\text{€} \text{ %} \text{ -}$  (PERCENT DISCOUNT) key. The value of the new rate will be effective only if it does not exceed the pre-programmed limit for manual entry and will apply for a single registration.

The discount or surcharge cannot be applied on goods that was set to returnable pack. If at sale, returnable pack's is accounted, after applying the surcharge or discount on the whole receipt, the discount or surcharge will be not applied on the returnable pack.

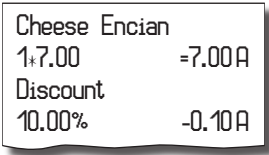

**Procedure for applying a programmed percent discount:** (condition: programmed values in the P-mode for surcharges and discounts, see the chapter „Programming the cash register - Surcharges and discounts“). We want to apply a programmed 10% discount on Cheese Encian:

Sequence of steps	Display	Receipt
POS 1 PLU	1*Cheese Encian 7.00	
-€ %-	Discount %- -0.10	
TL TOTAL	Cash 6.90 EUR	

• the procedure for applying a surcharge is similar, only in place of the key  (PERCENT DISCOUNT) we press  (PERCENT SURCHARGE).

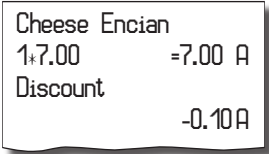
**Procedure for manually entering a percent discount:** (conditions: programmed limits in the P-mode for surcharges and discounts, see the chapter „Programming the cash register - Surcharges and discounts“). We want to apply a discount on Cheese Encian (if a surcharge or discount is more than the limit for manual entry, an error message is shown):



Sequence of steps	Display	Receipt
POS 1 PLU	1*Cheese Encian 7.00	
5 -€ %-	Discount %- -0.10	
TL TOTAL	Cash 6.90 EUR	

• the procedure for applying a manually entered percent surcharge is similar, only in place of the key  (PERCENT DISCOUNT) we press  (PERCENT SURCHARGE).

### Percent surcharge/discount on a subtotal

**Procedure:** If all items in a single transaction (purchase) are subject to the same discount or surcharge, it is possible to register the discount or surcharge at one time for the entire transaction (purchase). Once the entire sale has been registered (all items), press  SUBTOTAL and then apply the programmed surcharge or discount or to do so by manual entry.

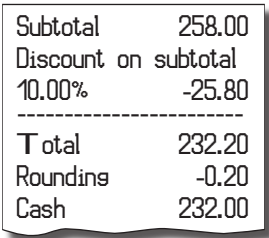
**Example:** for discretionary items sold with a total price, for example, of 258.00 EUR we apply a programmed 10% discount:

Sequence of steps	Display	Receipt
items sold		
 SUBTOTAL	Subtotal 258.00 EUR	
-€ %-	Zl'ava %- -25.80	
TL TOTAL	Hotovost 232.00 EUR	



- the procedure for applying a percent surcharge on an entire purchase is similar, only in place of the key  $\boxed{-\text{€}} \boxed{\% -}$  (PERCENT DISCOUNT) we press  $\boxed{+\text{€}} \boxed{\% +}$  (PERCENT SURCHARGE).

**Process for manually entering a discount:** we use the previous example but with a manually entered 4% discount.

Sequence of steps	Display	Účtenka														
predaj položiek		<table border="1"> <tr><td>Subtotal</td><td>258.00</td></tr> <tr><td>Discount on subtotal</td><td></td></tr> <tr><td>4.00%</td><td>-10.30</td></tr> <tr><td colspan="2">-----</td></tr> <tr><td>Total</td><td>247.70</td></tr> <tr><td>Rounding</td><td>-0.20</td></tr> <tr><td>Cash</td><td>247.50</td></tr> </table>	Subtotal	258.00	Discount on subtotal		4.00%	-10.30	-----		Total	247.70	Rounding	-0.20	Cash	247.50
Subtotal	258.00															
Discount on subtotal																
4.00%	-10.30															
-----																
Total	247.70															
Rounding	-0.20															
Cash	247.50															
$\boxed{\text{ST}} \boxed{\text{SUBTOTAL}}$	Subtotal 258.00 EUR															
$\boxed{\text{DIS}} \boxed{4} \boxed{-\text{€}} \boxed{\% -}$	Discount %- -10.30															
$\boxed{\text{TL}} \boxed{\text{TOTAL}}$	Cash 247.50 EUR															

- the procedure for applying a manually entered percent surcharge on an entire purchase is similar, only in place of the key  $\boxed{-\text{€}} \boxed{\% -}$  (PERCENT DISCOUNT) we press  $\boxed{+\text{€}} \boxed{\% +}$  (PERCENT SURCHARGE).

### Value surcharges and value discounts

The cash register allows for the application of a value surcharge or discount on the most recently registered item or on all the items sold. The size of the value surcharge or discount entered cannot be greater than the value of the item or the group of items to which the surcharge or discount applies.

Entering the value discount/surcharge is limited by the surcharge/discount limit. If the limit of the surcharge/discount is set to 0, the surcharge/discount cannot be applied. If the value is different than 0, the mentioned operation is allowed.



**The procedure for entering a value discount on a subtotal:** We will use the previous example but with a manually entered value discount of 100.00 EUR.

Sequence of steps	Display	Účtenka												
predaj položiek		<table border="1"> <tr><td>Subtotal</td><td>258.00</td></tr> <tr><td>Discount on subtotal</td><td></td></tr> <tr><td></td><td>-100.00</td></tr> <tr><td colspan="2">-----</td></tr> <tr><td>Total</td><td>158.00</td></tr> <tr><td>Cash</td><td>158.00</td></tr> </table>	Subtotal	258.00	Discount on subtotal			-100.00	-----		Total	158.00	Cash	158.00
Subtotal	258.00													
Discount on subtotal														
	-100.00													
-----														
Total	158.00													
Cash	158.00													
$\boxed{\text{ST}} \boxed{\text{SUBTOTAL}}$	Subtotal 258.00 EUR													
$\boxed{\text{DIS}} \boxed{1} \boxed{0} \boxed{0} \boxed{.} \boxed{0} \boxed{0} \boxed{\text{SHIFT}} \boxed{-\text{€}} \boxed{\% -}$	Discount -100.00													
$\boxed{\text{TL}} \boxed{\text{TOTAL}}$	Cash 158.00 EUR													

- the procedure for applying a value surcharge on a subtotal is similar, only in place of the keys  $\boxed{\text{SHIFT}} \boxed{-\text{€}} \boxed{\% -}$  we press  $\boxed{\text{SHIFT}} \boxed{+\text{€}} \boxed{\% +}$ .

**Procedure for entering a value discount on a single item:** a discount on Encian cheese worth 5.00 EUR

Sequence of steps	Display	Účtenka
POPS 1 PLU	1*Encian cheese 27.00	
5 0 0 SHIFT -€ %-	Discount -5.00	
TL TOTAL	Cash 22.00 EUR	

- the procedure for applying a value surcharge on a single item is similar, only in place of the keys  we press .





## REFUNDS

### Refund of a product

This function is used for reclamation or refunding of products for any reason whatsoever. This function can be used only as an independent operation. It cannot be used during an open (registered) sale.

In agreement with the regulation on the cash register registration, the value of a refunded product is counted as negative GT3 turnover. The menu „Refunds“ is used for the purpose of refunds.

**Procedure** for refunding the item Cheese Encian with a programmed price (7.00 EUR).

Sequence of steps	Display	Receipt
R-mode	08/05/2008 R 12:00:00	
press 	Registration of sale	
with arrows  or  go to the REFUNDS menu	REGISTRATION Refund	
confirm by pressing 	Refunded product	
POPS 1 PLU	1*Cheese Encian -7.00	
confirm by pressing 	CASH BACK 7.00 EUR	





**Note:**

*In the refund menu it is possible to use all the preceding methods for the sale of items (entering a price, multiplying, dividing amounts, ...). It is not possible to use the operation of surcharges or discounts!*

### Refund of a package

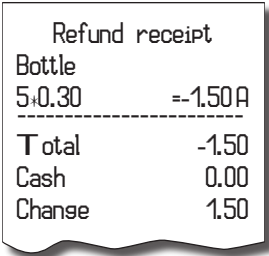
This function is use for the return of packages (bottle, crate, barrel, ...). In agreement with the regulation on cash register registration, the value of a refund operation is counted as negative GT3 turnover. In the cash register, the keys  PACKAGE REFUND) are used for this purpose. The packaging refund function can be used only as an independent operation or in the course of a registered sale.

Procedure for refunding five bottles programmed as PLU no. 20 with a programmed price (0.30 EUR). It is necessary that PLU no. 20 be programmed as a package refund (see the chapter „Programming the cash register - Product items“)







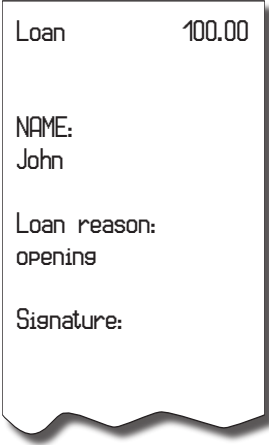

Sequence of steps	Display	Receipt
R mode	08/08/2008 R 12:00:00	
press the buttons 	Package refund	
	5*	
	5*Bottle -1.50	
complete the receipt by pressing 	Cash back 1.50 SKK	

With the refund of a package it is possible to use all preceding methods of registering items (entering of a price, multiplication, division of amounts, ...). However, it is not possible to use the operation for surcharges or discounts!

## DEPOSITING CASH

A deposit is used for the recording of non-business payments (deposits). An example is the daily adding of cash to the cash register drawer. The cash register allows the depositor to print proof of the cash deposit. The document can even include the name of the depositor and the reason for the deposit. A name and a reason can be entered up to 18 characters. There is a place assigned for the signature of the depositor on the printed document. Entering the name of the depositor and the reason for the deposit is not mandatory. If you do not want to enter this data, simply end the deposit operation by pressing  TOTAL two times.

**Procedure** for depositing 1000.00 SKK in the primary currency:

















Sequence of steps	Display	Receipt
R mode	08/08/2008 R 12:00:00	
press 	REGISTRATION Sale	
use the arrow keys  or  to go to the Deposit Cash menu	REGISTRATION Cash loan	
confirm by pressing 	VALUE :	
	VALUE : 100.00	
enter the cashier's name, confirm by pressing 	NAME : John	
enter the reason for the deposit, confirm with 	LOAN REASON : opening	

Print out the receipt; in the lower part there is a place where the cashier can sign the document.

## WITHDRAWAL OF CASH OR CHECKS

The withdrawal of cash or checks from the cash register drawer not associated with a sale is recording using the „with. cash/checks“ operation. We use this function, for example, when delivering revenue with alternate cash registers or to decrease the amount of money in the drawer. The cash register allows for the printing of a document on the withdrawing of cash. The document can even include the name of the person withdrawing and the reason for it. A name and a reason can be entered up to 18 characters. There is a place assigned for the signature of the person making the withdrawal on the printed document. Entering the name of the person withdrawing and the reason for the withdrawal is not mandatory. If you do not wish to enter this data, simply end the withdrawal operation by pressing  TOTAL two times.

An example of the pick up of 500.00 SKK (primary currency in cash):

Sequence of steps	Display	Účtenka
R mode	08/08/2008 R 12:00:00	Pick up 500.00
press 	REGISTRATION Sale	NAME: John
using the arrow  or  go to the Withdrawal of cash/checks menu	REGISTRATION Pick up of cash/checks	Pickup reason: Closing day
confirm by pressing  , for the withdrawal of checks, with the arrows  or  go to the Checks - primary currency	Pick up of cash/checks Cash primary currency	SIGNATURE:
confirm by pressing 	VALUE :	
      	VALUE : 500.00	
enter the cashier name, confirm with 	NAME : John	
enter the reason for withdrawal, confirm with 	PICKUP REASON : Closing day	

**TIP:** If you wish to take out the entire contents of the drawer (for example, a withdrawal in the primary currency) it is imperative to enter 0.00 as the value of the withdrawal.

At certain transactions, reference number is needed to be entered. Reference number is entered from the numeric pad after which the key combination SHIFT  has to be pressed. Limit of the reference number is 16 characters.

## ENTER REFERENCE NUMBER

On receipt, customer identification number can be entered. At open receipt, or before start of the receipt, enter the customer number and press SHIFT  key combination. Maximum length of the reference number is 18 characters. On display will be the preset value which by default is "Reference number" and the value of the reference number. It's possible to continue with accounting. This number will be printed on receipt in the section "informative data".

Reference number is possible to read with help of the bar code scanner. As reference number will be considered the EAN code starting with 25.

## **REGISTRATION USING THE EURO CURRENCY**

Prior to devoting yourself to this chapter, read the chapter „Concepts defining the launch of the euro currency or payment in a foreign currency“. The Euro-50TE Mini cash register is capable of working with a primary, foreign (secondary) and dual currencies according to the stages of the euro currency currently in effect.



**Note:**

*Because of the possibilities for setting different number of decimal places for different currencies (for example, for the depiction and programming of prices in EUR in 3 or 2 decimal places, for the SKK, or for another foreign currency depiction and programming of prices for 2 decimal places) we recommend that when entering values to the cash register that you use a decimal point. For example, for entering 23.00, it is enough to press 23., for entering 38.500 it's enough to press the keys 38.5 and the register will automatically fill out the tenths place according to the setting of the character for the given currency for depicting and programming prices.*

### **Stage prior to announcement of the conversion rate**

The cash register works with a primary currency, which is the Slovak crown, and can also work with a foreign (secondary) currency, which can be an optional foreign currency, including the euro. In the foreign (secondary) currency, payments can only be made in cash. In the course of a single purchase it is possible to alternate payment in both the primary and the foreign currency and thus complete a sale. Any change, however, can only be given in the primary currency.





**Procedure:**

After pressing  SUBTOTAL the value of the purchase is shown on the display in the primary currency. By pressing  PRICE the value of the purchase is calculated for the value in the foreign currency. With repeated pressing of the  PRICE ey, the subtotal is calculated and displayed in the primary or foreign currency. After removing the necessary currency, the purchase ends by pressing the relevant payment button; in the foreign (secondary) currency payments can only be made in cash. The method of payment and payments in the primary and foreign currencies can be combined in various ways.

**Note:**

*For payments in the foreign (secondary) currency, the second currency must already be programmed in (see the chapter Programming the cash register - Currencies)*

**Example:** A coat is bought for 2500 Sk. The customer wants to pay 20 EUR in cash, 1000 Sk with a credit card and the rest in cash with SKK.

Sequence of steps	Display	Receipt
sale items		Coat, black 1*2500.00
	Subtotal 2500.00 SKK	Subtotal 2500.00 A
	Subtotal 77.82 EUR	----- Total 2500.00
TW 2 AD+ 0 -<B> 0 AD+ 0 TL TOTAL	Payment 57.82 EUR	20.00 EUR= Cash 642.47
	Payment 1857.50 SKK	Credit 1000.00
POB 1 AD+ 0 AD+ 0 -<B> 0 AD+ 0 SHIFT CR SCALE	Payment 857.50 SKK	Cash 857.50
	Cash 857.50	----- Taxable A 2500.00
		Without VAT A 2100.80
		VAT A 19.00% 399.20
		----- Total sale 2500.00
		Total without VAT 2100.80
		Total VAT 399.20
		----- Informational data Exchange rate 1EUR =-32.1234 SKK

All financial data are preserved in the primary currency. The changeover to individual stages is described in the programming part of this manual.

## Stage of dual display



Lasts from the announcement of the conversion rate to the start of the changeover to the euro. The conversion rate will be announced about half a year before entry to the eurozone. At this stage the mandatory dual display of prices is in effect, no sooner than the day of the announcement and at the latest 1 month after announcement of the conversion rate. The cash register works with two currencies. The primary currency is the Slovak crown, while the dual and foreign (secondary) currency is the euro. Dual currencies serves for informational display of prices for purchases; for the need of dual display, they are calculated using the conversion rate. In the foreign currency, only cash payments are possible, while change can only be given in the primary currency. Payments in the euro currency are in calculated Slovak crowns according to the market exchange rate, not according to the conversion rate.

Informational data	
Total EUR	79.54
Exchange rate	
1EUR	=-31.4321 SKK















## Stage of dual circulation - entry to the eurozone

This is the stage of gradual withdrawal of the Slovak crown from circulation, which will last for 16 days. In this period the mandatory dual display of prices remains in place. The cash register works with two currencies. The primary currency is the euro. The dual and foreign currency is the Slovak crown. It is possible to make payment in the foreign currency (SKK) only in cash. In the course of a single purchase it is possible to alternate payment in both the primary and the foreign currency and thus complete a sale. Any change, however, can only be given in the primary currency (EUR). Prior to the first registering of a sale in the stage of dual circulation, it is necessary to perform the calculation of PLUs recorded in the cash register database from the Slovak crown to the euro. The values of cumulated sums (so-called grand totals) will be during the changeover calculated on the basis of a conversion rate. It is necessary to calculate the prices of items outside the cash register according to the rules defined by the law on the introduction of the euro and afterwards it will be necessary to enter the correct prices directly into the cash register via the programming mode.

### Procedure:

After pressing  SUBTOTAL the value of the purchase is displayed in the primary currency (euro). By pressing  PRICE the value of the purchase is calculated in the foreign currency (in this phase, SKK). By repeating the pressing of  PRICE the value of the subtotal is calculated and shown in the primary or foreign currency. After selection of a currency, the sale is completed by pressing the relevant payment button; in the foreign (secondary) currency payment can only be made in cash. The method of payment and payments in the primary and foreign currency can be combined in a variety of ways.

**Example:** A coat is purchased for 100 EUR. The customer wants to pay 10 EUR in cash, 10 EUR with a credit card and the rest he wishes to pay in cash in EUR.

Sequence of steps	Display	Receipt
items sold		
	Subtotal 120.00 EUR	Black Jacket 1,120.00 120.00 A Subtotal 120.00 A
 1  0  .  0  0  TOTAL	To Pay 10.00 EUR	Total 120.00 Cash 100.00 Cash 10.00 Cash 10.00
 1  0  .  0  0  SCALE	To Pay 10.00 EUR	Taxable A 120.00 Netto A 100.80
	To Pay 120.00 EUR	VAT A 19.00% 19.20 Sale total 120.00 Netto total 100.80 VAT total 19.20
	Cash 120.00 EUR	----- 13-11-2008 13: 49 01-0033 Cashier

All financial data are stored in the primary currency (euro). The changeover to individual stages is described in the programming parts of this manual.

## Stage of mandatory dual display

This stage will last until the end of 2009.

This is the stage of the changeover to the euro after the completion of dual circulation with the possibility of using another foreign currency. The primary currency is now the euro, the dual currency is the Slovak crown and a foreign (secondary) currency is an optional foreign currency. No payments may be made nor change given in the dual currency (EUR). It serves merely for informational depiction of prices for purchases.

**Process:**

After pressing **ST** SYSTEM SUBTOTAL the value of the purchase is displayed in the primary currency (euro). By pressing **PRICE** the value of the purchase is calculated in the foreign currency. By repeating the pressing of **PRICE** the value of the subtotal is calculated and depicted in the primary or foreign currency. After selection of a currency, the sale is completed by pressing the relevant payment button; in the foreign (secondary) currency payment can only be made in cash. The method of payment and payments in the primary and foreign currency can be combined in a variety of ways.

**Note:**

For payments in the foreign (secondary) currency it is necessary for this currency to be programmed into the register (see the chapter Programming the cash register - Currencies )

**Example:** A coat is purchased for 80 EUR. The customer wants to pay 30 USD in cash, 20 EUR with a credit card and the rest he wishes to pay in cash in EUR.

Sequence of steps	Display	Receipt
<b>ST</b> <small>SYSTEM</small>	Subtotal 80.00 EUR	Coat, black 1x80.00 80.00A Subtotal 80.00A
<b>PRICE</b>	Subtotal 116.55 USD	----- Total 80.00
<b>3</b> <b>0</b> <b>.</b> <b>0</b> <b>0</b> <b>TL</b> <small>WXYZ</small> <small>RD+</small> <small>RD-</small> <small>RD+</small> <small>RD-</small> <small>TOTAL</small>	Payment due 86.55 USD	30.00USD= Cash 20.59
<b>PRICE</b>	Payment due 59.41 EUR	Credit 20.00 Cash 39.41
<b>2</b> <b>0</b> <b>.</b> <b>0</b> <b>0</b> <b>SHIFT</b> <b>CR</b> <small>TRV</small> <small>RD+</small> <small>RD-</small> <small>RD+</small> <small>RD-</small> <small>SHIFT</small> <small>CR</small> <small>SCALE</small>	Payment due 39.41 EUR	----- Taxable A 80.00 Without VAT A 67.23 VAT A 19.00% 12.77
<b>TL</b> <small>TOTAL</small>	Cash 39.41 EUR	Total sale 80.00 Total without VAT 67.23 Total VAT 12.77
		----- Informational data Total SKK 2514.57 Conversion rate 1EUR =-31.4321SKK  Exchange rate 1USD =-0.6864EUR

All financial data are stored in the primary currency (euro). The changeover to individual stages is described in the programming parts of this manual.

**The end of dual display**

The recommended end of the dual price display is June 2010. After completion of dual display, the primary currency is the euro and the second is an optional foreign currency. Payments in the foreign (secondary) currency can only be made in cash. In the scope of a single purchase it is possible to alternate payment in the primary and foreign currency up to the total payment for the purchase. Change can only be given in the primary currency. The method of ending dual display is described in the programming section of this manual.



## **TEXT JOURNAL**

The cash register store on memory the control receipts in electronic form. Text journal has capacity for 18.990 lines (including empty lines), which at receipts with 3 items and 3 different tax levels equals to 450 receipts. To fulfill the law requirements, the text journal has to be stored regarding local law regulations.

The cash register Euro-50TE Mini allows to store the journal on PC with the communication library functions or to export on memory card (not included). The cash allows to set automatic export journal on SD card at daily report (P mode > Journal > Setting > Autoexport). At this setting implicit saving of the journal will be done and later, erasing of it from internal memory if the transfer to SD card or PC is successful.

In case of need the cash register allows to print the text journal on paper. The text journal is not possible to erase if the journal is not stored on PC, memory card or printed on paper ribbon. During accounting, message for operator is displayed, informing about journal low memory. This message is displayed at starting the cash register if the memory reached 80% and after crossing 95%. In that case is recommended to store the journal, delete it and continue with accounting. After the journal memory is full, the cash register is not allowing to start with new receipt or any other fiscal operation until it's not stored on PC, memory card or printed on paper.

## **BINARY JOURNAL**

It's used to store information about sale and further parse and decode with help of PC software. Enabling storing binary journal can be done in menu P mode > Binary journal > Setting (see chapter Programming of ECR ). Other operation with the binary journal are : export on SD card, deleting, getting size information. The cash register check status of journal and at passing 80% of memory usage, the cash register operator will be informed about this status.

Binary journal is based on documents. Current only sell and refund in registering and training mode documents are available. Each document contains items and special form has headers and footer which are delimiting the document.

Each receipt contains elements that are separated with TAB (0x09). Each item is finished with the end of line sign NL (0x0A).

### **Description of binary journal elements**

<b>DocumentHeader – beginning of the document</b>		
<b>DOCHDR</b>	dt	
	dt:	DocumentType – valid values
		SALE/RETURN/SALET/RETURNT/LOAN(*)/LOANT(*)
		Letter T at the end of document type indicate training mode

*(\*) – Receive on account operation is logged only in fiscal version*

<b>SoldItem</b> – sold, refunded, canceled item	
<b>SI</b>	id text uuuu pppp q1 qo q2 rrrr i C D R L V
id:	ID of the item at purchase
text:	PLUName
uuuu:	UnitPrice
pppp:	Price
q1:	First amount
q2:	Second amount
qo:	QuantityOperator – valid values * and /
rrrr:	taxRate
i:	TaxIdentifier – valid values A/B/C...
C:	Container item – presence of this item depends on sold item type
D:	Descriptive item - presence of this item depends on sold item type
R:	Return operation – presence of this item depends on operation type
L:	Linked item – this item tells if the item is linked to any other item
V:	Void operation - presence of this item depends on operation type. If this operation is done, the value "id" is identifying the item that was canceled

<b>ItemAdjustment</b> – Entry changing price for other item	
<b>ADJI</b>	id adjt pppp aaaa V
id:	ID of entry from sale, that has changed price
adjt:	AdjustmentType – valid values P+/P-/V+/V-
pppp:	Value of percentual modification of P+ and P-
aaaa:	Value of modification
V:	Void operation – presence of this value depends on type of operation

<b>Void of Receipt</b> – item identifies canceling of the purchase	
<b>RCPV</b>	After this entry the RPCDT and RPCID is following

<b>SubtotalAdjustment</b> – entry that changes value of subtotal	
<b>ADJSBTL</b>	id adjt pppp ssss aaaa V
id:	ID of this entry on receipt
adjt:	AdjustmentType – valid values P+/P-/V+/V-
pppp:	Value of percentual modification of P+ and P-
ssss:	Value of subtotal, that will be modified (without returnable containers and linked items)
aaaa:	Value of modification
V:	Void operation - presence of this item depends on operation type. If this operation is done, the value "id" is identifying the item that was canceled

TenderItem – payment entry		
<b>TNDR</b>	ct	tt aaa ffff rrrr
	ct:	CurrencyType – valid values CURN/CURF for local/foreign currency
	tt:	TenderType – valid values CASH/CHECK/CARD
	aaaa:	Amount – value of the payment in local currency
	ffff:	Foreign – value of the payment in foreign currency
	rrrr:	ExchangeRate – of the foreign currency in case that the payment was covered with foreign currency

TotalItem – sell summary		
<b>TTL</b>	gggg	tttt rrrr
	gggg:	Gross – total value of the purchase including tax
	tttt:	Tax – total value of the tax
	rrrr:	Rounding – value of the price rounding of the purchase. This value can be negative

TaxItem – entry of tax level used at purchase		
<b>TAXI</b>	tl	rrrr gggg tttt
	tl:	TaxLevel – valid values A/B/C ...
	rrrr:	TaxRate – tax value in percents
	gggg:	Value of purchase including tax from specific tax level
	tttt:	Value of tax in tax level

DocumentReferenceNumber		
<b>DOCRFN</b>	nnnnn	
	nnnnn:	Reference number of the document

	DD.MM.YYYY	HH:MN:SS
--	------------	----------

ReceiptDateTime - date and time of receipt		
<b>RCPID</b>	nn	rrrr OperatorName
	nn:	ECR number
	rrrr:	ReceiptNumber – zero for LOAN and LOANT

DocumentTrailer – End of document		
<b>DOCTR</b>		

Example of binary journal document in text form:												
DOCHDR SALE												
SI	1	bread	10.00	60.00	2.000	*	3.000	19.00	A			
SI	2	sausage	20.00	240.00	3.000	*	4.000	10.00	B			
SI	3	bottle	4.00	4.00	1.000	*	1.000	0.00	G	C		
SI	4	beer	30.00	30.00	1.000	*	1.000	0.00	G			
SI	5	bottle	4.00	4.00	1.000	*	1.000	0.00	G	C		
ADJI	4	P-	10.00	3.00								
SI	7	beer	30.00	30.00	1.000	*	1.000	0.00	G			
SI	8	bottle	4.00	4.00	1.000	*	1.000	0.00	G	C		
ADJI	7	P-	10.00	3.00								
ADJI	7	P-	10.00	3.00	V							
SI	10	beer	30.00	30.00	1.000	*	1.000	0.00	G			
SI	11	bottle	4.00	4.00	1.000	*	1.000	0.00	G	C		
SI	12	beer	30.00	30.00	1.000	*	1.000	0.00	G			
SI	13	bottle	4.00	4.00	1.000	*	1.000	0.00	G	C		
ADJI	12	P+	10.00	3.00								
SI	12	beer	30.00	30.00	1.000	*	1.000	0.00	G			
	V											
SI	13	bottle	4.00	4.00	1.000	*	1.000	0.00	G	C		
	V											
ADJI	12	P+	10.00	3.00	V							
SI	15	bottle	4.00	4.00	1.000	*	1.000	0.00	G	C	R	
SI	15	bottle	4.00	4.00	1.000	*	1.000	0.00	G	C	R	
	V											
SI	16	bread	10.00	10.00	1.000	*	1.000	19.00	A			
ADJI	16	P-	10.00	1.00								
ADJI	16	P-	10.00	1.00	V							
ADJSBTL	18	P+	10.00	397.00	39.70							
ADJSBTL	19	P+	10.00	436.70	43.70							
ADJSBTL	19	P+	10.00	436.70	43.70	V						
TNDR	CURN	CASH	452.50	0.00	0.0000							
TTL	452.50	36.30	-0.20									
TAXI	A	19.00	77.00	12.30								
TAXI	B	10.00	263.90	24.00								
TAXI	G	0.00	111.60	0.00								
DOCRFN	987654321											
RCPDT	21.01.2008	17:11:02										
RCPID	01	0056	Cashier01									
DOCTR												

# ***REPORTS***

## **REPORT MODES**

There are two modes for printing reports: "X" mode and "Z" mode.

An „X“ mode report is printed without clearing the contents of the memory. It is used for generating an overview of sales during the day, when switching cashiers and the like. An „X“ mode report may be printed out at different times during the day.

Use "Z" mode reports when you need to print reports and to clear the register's memory of the sales data printed in the report. A "Z" report is usually carried out once a day after finalising the daily sales.

Reports are always printed in the primary currency.

## **GENERATED REPORTS**

**Table 5.1 - An overview of reports in the „X“ and „Z“ modes**

Report	„X“ mode	„Z“ mode
Daily (total)	•	•
Monthly (periodical)	•	•
Daily turnover	•	•
Cashiers report	•	•
DPT report	•	•
PLU report	•	•
Drawer report	•	•

## **REPORT CONTENTS**

### **Financial reports**

*A financial report contains:*

- 1) The values of cumulated sums (grand totals) GT1, GT2 and GT3
- 2) Taxable sums and taxes in all programmed taxation categories
- 3) Overall sales value
- 4) Overall sales value without tax
- 5) Value of total tax
- 6) Number and value of voids
- 7) Number and value of refunds
- 8) Number and value of discounts
- 9) Number and value of surcharges
- 10) Number and value received by cash payment
- 11) Number and value received by check payment
- 12) Number and value received by credit card payment
- 13) Number and value of deposits in cash
- 14) Number and value of withdrawals in cash
- 15) Differences in rounding

Inactive categories (that is with zero sales information) are not printed out (with the exception of tax information).

### **Daily financial X-report**

A daily (overall) X-report includes:

- the number of all daily (overall) Z-reports (ZD#) already performed
- financial report

## Monthly financial X-report

A monthly (periodic) X-report collects financial data from the daily (overall) Z-reports accumulated over a time period. This report allows the printing out of financial data accumulated from the last monthly (periodic) Z-report. Does not clear the register memory.

## Daily turnover

This is a simple, fast report which shows the current daily turnover on the cash register display.

## X - cashier report



Daily / monthly X cashier report print out :

- Cashier name
- Number and value of the positive and negative sell summary and refund from the last Z-daily/monthly cashier report.
- Value of the total sell

The monthly X-report is actualized after Z-daily cashier report.

## PLU X-report

Procedure at printing the PLU X - report :

- Setting the lower limit, setting number of PLU, from which PLU report will be printed.
- Applying the setting with the key  TOTAL
- Setting the higher limit, setting number of PLU, until which PLU report will be printed.
- Applying the setting with the key  TOTAL
- Print entry number – at setting the entry number print to “Yes”, at each PLU the PLU number is printed.
- Applying the setting with the key  TOTAL

PLU X-report print out:

- Number of PLU (if the “Print entry number” was set to “Yes” )
- Name of PLU
- Number and value of sold PLU
- Addition of all sold PLU values

## DPT X-report

Daily / monthly DPT report prints out :

- Name of DPT
- Number and value of sold DPT
- Total value of all sold DPT per day / month

## X-Drawer report

The drawer report prints out :

- Number of cash contribution in drawer and additional value
- Number of returned goods and they additional value
- Number of received on account operations and the additional value of the received cash value
- Number of Paid out operations and the additional value of the paid out cash value
- Remaining money in the drawer
- Value of checks in the drawer
- Amount of the foreign currency in the drawer
- Number and sum of returned money

## Daily financial Z-report

A daily (overall) Z-report contains:

- sequential number of the performed daily (overall) „Z“ report (ZD#)
- financial report

After printing, the contents of the memory in a daily (overall) Z-report are added to the contents of the monthly (periodic) report and then zeroed out. According to applicable Slovak legislation a daily (overall) Z-report must be printed out at the end of each day.

## Monthly financial Z-report

A monthly (periodic) Z-report gathers information from daily (overall) Z-reports over a longer time period. By printing out the contents of the memory monthly (periodically) the Z-report is cleared. According to applicable Slovak legislation a monthly (periodic) Z-report must be printed out at the end of each month.

## Z-cashier report





Daily / monthly cashier Z-report prints out:

- Name of the cashier
- Number, additional value of positive and negative sells or refund of goods from the last Z-daily/monthly cashier report.
- Value of the total daily/monthly income

After printing the daily cashier report the information from the daily cashier report is added to monthly cashier report and it's deleted. After printing the monthly cashier report, this will be erased.

## PLU Z-report

Procedure at printing the PLU Z - report :

- Setting the lower limit, setting number of PLU, from which PLU report will be printed.
- Applying the setting with the key  TOTAL
- Setting the higher limit, setting number of PLU, until which PLU report will be printed.
- Applying the setting with the key  TOTAL
- Print of report – at this step if the setting for print out report is set to “Yes”, the PLU report will be printed in the preset interval. If the print out report is set to “No”, the PLU report will be not printed and it will be erased from the memory, that reset the counter and new tracking period can be started. In case that the setting “No” will be applied, the steps 7. and 8. will be not accomplished.
- Applying the setting with the key  TOTAL
- Printing the number of the PLU – at set to “Yes” each PLU the order number from the database will be printed.
- Applying the setting with the key  TOTAL

## PLU X-report print out:





- number of PLU (if the “Print entry number” was set to “Yes” )
- Name of PLU
- Number and value of sold PLU
- Total value of all sold DPT per day / month

After printing out the PLU Z-report, the information about sold PLU will be erased what allows periodic tracking of the goods.

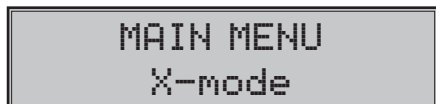
## HOW TO PRINT AN X-REPORT

Call up the Main Menu by pressing the MENU key, then using the arrows  or  select „X” mode.



Enter the X-report menu by pressing  TOTAL, where by using the  or  keys you can select which report you want to run. The report will be printed out after pressing the  TOTAL key.

We can print out X-reports any number of times without influencing the values of the data stored in the cash register.



With the help of this type of report, you can get an overview of sales during the day. You can use these values, for example, to check the balance of cash in the drawer, follow the course of sales throughout the day, check sales with the changing of shifts or cashiers, etc.

### Sample printouts of an X-report

A daily (overall) X-report offers a detailed picture of sales during the day. It lists data about sales by individual taxation rates, the number of operations and voids, the number of refunds and the amount of cash or checks accepted at the cash register. The actual revenues is at the same time divided from non-sales deposits and withdrawals.

The X-report is a favorite for checking sales revenues and cash during shift changes throughout the working day. It gives a manager an immediate overview of sales at any time during the day.

The number of all daily Z-reports is listed in the report as ZD#, while the number of monthly Z-reports appears as ZM#.

```

***** X *****
Financial report
Daily
*****
ZD #.                2
GT1                 1615.00
GT2                 1606.00
GT3                  -9.00
Tax rate A          19.00%
Tax rate B           10.00%
Tax rate C           ----
Tax rate D           ----
Tax rate E           ----
Tax rate F           ----
Tax free G
Taxable A           190.00
Netto A              159.70
VAT A                30.30
Taxable B            0.00
Netto B              0.00
VAT B                0.00
Tax free G           0.00
Sale total
50                  190.00
Netto total          159.70
VAT total            30.30
Cash
50                  190.00

13-11-2008          14: 06
01                  Cashier1
    
```

```

***** X *****
Financial report
Monthly
*****
ZM #.                0
ZD #                 1
GT1                 1615.00
GT2                 1606.00
GT3                  -9.00
Tax rate A          19.00%
Tax rate B           10.00%
Tax rate C           ----
Tax rate D           ----
Tax rate E           ----
Tax rate F           ----
Tax free G
Taxable A           1327.00
Netto A              1115.10
VAT A                211.90
Taxable B            0.00
Netto B              0.00
VAT B                0.00
Tax free G           0.00
Sale total
25Q                 1327.00
Netto total          1115.10
VAT total            211.90
Void
20                  -17.00
Discount
10                  -0.10
Surcharge
10                  0.10
Refund
20                  -8.50
STL discount
10                  -0.10
Receipt annulled
40                  -85.30
Loan
10                  100.00
Pick up
20                  1000.00
Cash
300                 1326.82
Roundings
50                  0.10

13-11-2008          14: 06
01                  Cashier1
    
```

## Z-Drawer report

The drawer report prints out:

- Number of cash contribution in drawer and additional value
- Number of returned goods and they additional value
- Number of received on account operations and the additional value of the received cash value
- Number of paid out operations and the additional value of the paid out cash value
- Remaining money in the drawer
- Value of checks in the drawer
- Amount of the foreign currency in the drawer
- Number and sum of returned money

After print the drawer Z-report, the information about drawer will be erased what allows periodic tracking of the operations with the drawer.

## DPT Z-report

Daily / monthly DPT report prints out:

- Name of DPT
- Number and value of sold DPT
- Total value of all sold DPT per day / month

After printing the daily DPT report the content of the daily report will be added to the monthly DPT report and after that it will be erased.

After printing the monthly DPT report, this will be erased.

## Z- Combined report Name

Combined report allows to define all reports, that have to be printed. For example two modes can be defined, one for daily purpose and one for monthly purpose.

Procedure at printing the daily combined report:

- Entering the execution or configuration
- Applying the setting with the key  TOTAL
- At setting of configuration:
- Setting print of financial report "Yes" or "No"
- Applying the setting with the key  TOTAL
- Setting print of cashier report "Yes" or "No"
- Applying the setting with the key  TOTAL
- Setting print of DPT report "Yes" or "No"
- Applying the setting with the key  TOTAL
- Setting print of PLU report "Yes" or "No"
- Applying the setting with the key  TOTAL
- Setting print of drawer report "Yes" or "No"
- Applying the setting with the key  TOTAL

\* Description of the reports is in the previous chapter

Procedure at printing monthly combined report:



- Entering the execution or configuration
- Applying the setting with the key  TOTAL

At setting of configuration:





- At entering the configuration of printing the financial report "Yes" or "No"
- Applying the setting with the key  TOTAL
- Setting print of financial report "Yes" or "No"
- Applying the setting with the key  TOTAL
- Setting print of cashier report "Yes" or "No"
- Applying the setting with the key  TOTAL

\* Description of the reports is in the previous chapter

## HOW TO PRINT OUT A Z-REPORT

Press the MENU button to enter the Main menu, then use the arrows  or  to select „Z“.



You get into „Z“ reports by pressing the  TOTAL key, where by using the keys  or  you can select the report you wish to run. The report will print out upon pressing the  TOTAL key.

### Sample printouts of an Z-report

```

***** Z *****
Financial report
Daily
*****
ZD #.                3
GT1                 1615.00
GT2                 1606.00
GT3                  -9.00
Tax rate A          19.00%
Tax rate B           10.00%
Tax rate C           ----
Tax rate D           ----
Tax rate E           ----
Tax rate F           ----
Tax free G
Taxable A           190.00
Netto A             159.70
VAT A               30.30
Taxable B            0.00
Netto B              0.00
VAT B                0.00
Tax free G           0.00
Sale total
50                  190.00
Netto total         159.70
VAT total           30.30
Cash
50                  190.00

13-11-2008          14: 07
01-0006             Cashier1
    
```

```

***** Z *****
Financial report
Monthly
*****
ZP #.                2
ZD #                 3
GT1                 1615.00
GT2                 1606.00
GT3                  -9.00
Tax rate A          19.00%
Tax rate B           10.00%
Tax rate C           ----
Tax rate D           ----
Tax rate E           ----
Tax rate F           ----
Tax free G
Taxable A           1517.00
Netto A             1274.80
VAT A               242.20
Taxable B            0.00
Netto B              0.00
VAT B                0.00
Tax free G           0.00
Sale total
300                 1517.00
Netto total         1274.80
VAT total           242.20
Void
20                  -17.00
Discount
10                  -0.10
Surchargee
10                   0.10
Refund
20                  -8.50
STL discount
10                  -0.10
Receipt annulled
40                  -85.30
Loan
10                  100.00
Pick up
20                  1000.00
Cash
350                 1516.82
Roundings
50                   0.10

13-11-2008          14: 07
01-0001             Cashier1
    
```



# ***OPTIONAL ACCESSORIES***

## Digital scales

The Euro-50TE Mini cash register allows for the connection of digital electronic scales with an optional RS-232 interface. You can also use them without a connection to the cash register. We supply scales with official certification and on request with a connecting cable.

**Figure 6.2 - Digital scales**



Ask your authorised Euro-50TE Mini dealer about the supply and connection of an electronic scale.

## Bar-code scanners

The Euro-50TE Mini cash register should be optionally equipped with an interface for connecting a bar-code scanner. If you decide to use a bar-code scanner, this section offers some recommendations for how to choose one. In each case we recommend buying and connecting a scanner with the help of your local Euro-50TE Mini dealer.

We connect a bar-code scanner to the cash register via optional a built-in serial RS-232 interface. The bar-code scanner must be equipped with the same interface. For a scanner connection, the cash register offers a single direction +5V adapter for the COM1 (Port1) port; if you are using the COM2 port (Port2) to connect the scanner, you must use an external connection. Prior to connecting a scanner it is necessary to correctly program both the scanner and the cash register. We recommend using a scanner with its own connection.

We recommend Metrologic scanners for working with the cash register. Ask your Euro-50TE Mini dealer for more information.

### MS-5145 Eclipse

A manual scanner with no holder, which scans upon the pressing of a trigger. The method of scanning is the LED 650 nm  $\pm$  5 nm, scanner speed is 72 lines/s, scanning distance is 140 mm and the minimal width of the bar is 0.102 mm. RS-232 interface.

**Figure 6.3 - MS-5145 Eclipse scanner**



### Metrologic Orbit MS-7120

An omnidirectional, very fast, laser bar-code scanner. The scanner uses an LED 650 nm  $\pm$  5 nm for scanning, the speed of the omnidirectional scanning is 1120 lines/s (20 scanning lines), scanning grid of 5 x 4 parallel lines, scanning distance is 203 mm and the minimum bar width of 0.13 mm.

**Figure 6.4 - Metrologic Orbit MS-7120 scanner**



**Metrologic MS-9520 Voyager**

A hand-held single-line laser scanner with automatic bar-code scanning, also offered with a holder. The method of scanning is an LED 650 nm  $\pm$  10 nm, scanning speed is 72 lines/s, scanning distance of 203 mm and the minimum bar width is 0.132 mm.

**Figure 6.5 - Metrologic MS-9520 Voyager scanner**



**Birch CD-108e**

A great favorite, this hand-held CCD scanner is characterised by its low energy consumption, which makes it suitable for connecting to a cash register working on a battery or to a laptop computer. This scanner is ergonomically designed and reliably reads all commonly used bar codes, and working with it, including configuration settings, is simple and easy for all users. It uses a CCD scanning with a speed of 100 scans per second.

**Figure 6.6 - Birch CD-108e scanner**



You can get information about other types of scanners from your authorised Euro-50TE Mini cash register dealer. You can find a complete list of scanners sold on our Web site: [www.elcom.eu](http://www.elcom.eu).





# ***HELPFUL ADVICE***

## HELPFUL ADVICE

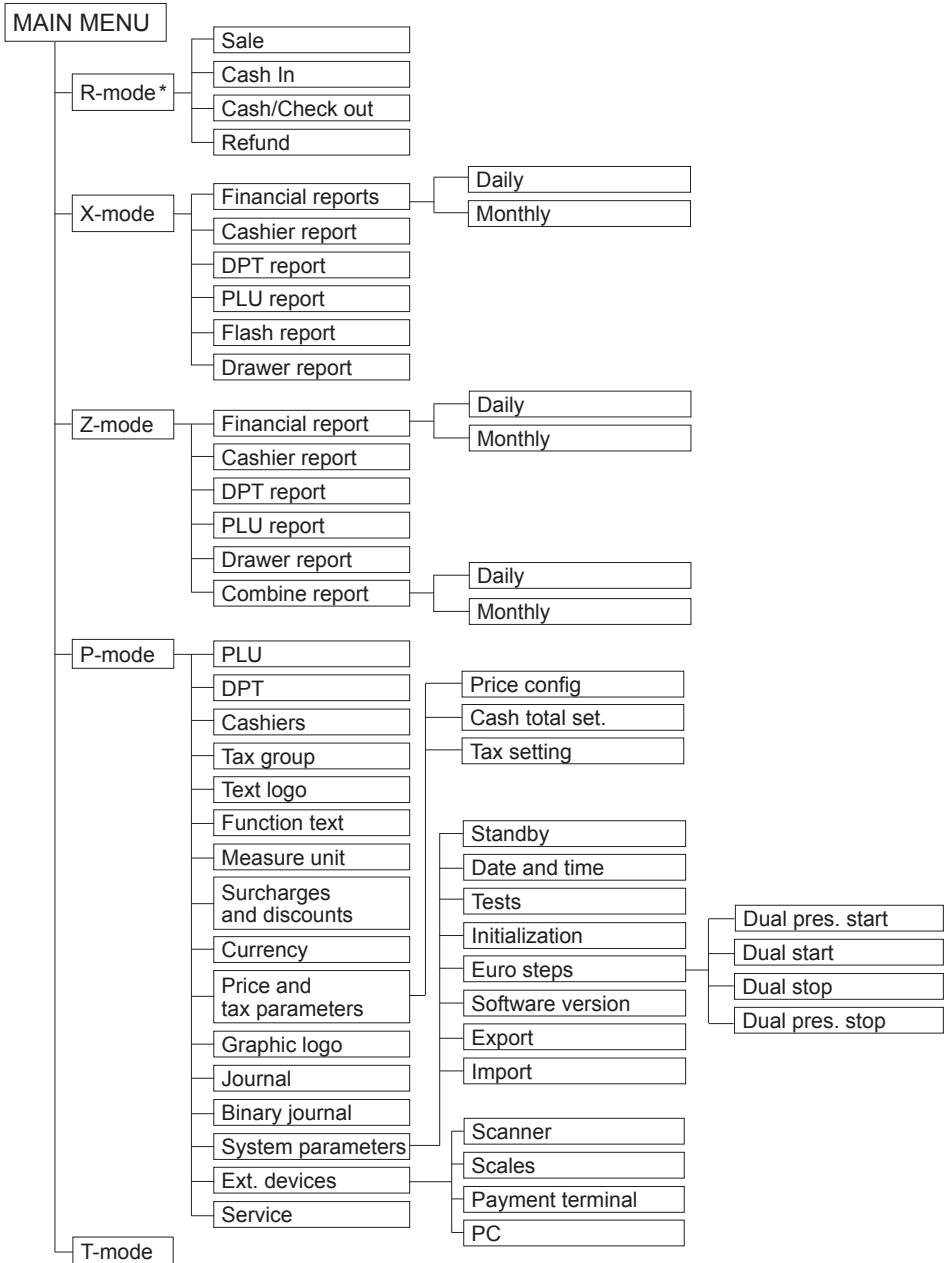

\* from the main menu, after selecting R-mode, go directly to "Sales", you get into the menu for registration mode by pressing  (MENU) from the sales mode

## INFORMATION AND ERROR MESSAGES

If it is necessary to inform the operator about the current activities of the cash register or if the register enters into an error state, the following messages will appear on the display:

**Table 7.1 - List of cash register messages**

MESSAGE	MEANING
Head lifted	The printer head is lifted.
Error journal paper	There is no journal paper in the printer.
Error Receipt paper	There is no receipt paper in the printer.
Printer disconnected	Communication with the printer was unsuccessful. Printer is probably disconnected.
Purchase limit exceeded	The operation was not performed because it would cause the exceeding of the purchase limit.
Printer head warm	Printing of data was stopped. Cooling of the printer head is required.
Purchase paid complete transaction	The memory for recording sales was fulfilled. Purchase must be voided or paid (The limit for one sale is 31 PLUs).
Make final payment	Limit reached for the number of partial payments allowed in a purchase. Full amount must be paid.
Value limit of surcharge/discount	The entered value cannot be zero and less than the price of the item, or the value of the subtotal.
Percent limit of surcharge/discount	The entered value cannot be zero, less than the programmed limit and no greater than 100%.
Value of purchase is zero	A surcharge/discount cannot be applied to a subtotal whose value is negative or zero.
Not possible to change price	It is not possible to apply a surcharge/discount to the selected item - for example, a refundable package.
Purchase contains refunded goods	It is not possible to apply a surcharge/discount to a subtotal because the purchase contains refunded goods.
Limit exceeded for 1st amount	First amount exceeds limit.
Limit exceeded for 2nd amount	Second amount exceeds limit.
Limit exceeded for amount	Resulting amount exceeds limit.
Invalid 1st amount	A zero or very large (invalid) value for the first amount.
Invalid 2nd amount	A zero or very large (invalid) value for the second amount.

Invalid amount	A zero or very large (invalid) value for the resulting amount.
Invalid unit price	A zero or very, very large unit price for an item was entered.
Deposit not allowed	The requested deposit is not allowed.
Withdrawal not allowed	The requested withdrawal is not allowed.
Insufficient currency in the drawer	Pay out not possible – the cash register drawer does not have the requested amount.
Inactive PLU	A PLU with an undefined name or assigned an inactive taxation level cannot be registered. Equally, an item with a zero-programmed price and no price for registration cannot be registered.
Not possible to enter another price	Item does not allow for entering unit price for registering.
Invalid PLU	The item with the entered number or bar code is not in the register database.
Price cannot be zero	A resulting price of zero for an item is not allowed.
No items registered	The requested operation cannot be performed because the purchase contains no PLUs.
Operation impossible in state entered	In the mode for refunding goods, only registration of PLUs, its voiding and a one-time payment in the sense of refunding cash to a customer is allowed.
PLU is not for a returnable package	The given PLU cannot be used in an operation for buying back returnable packaging.
Linked PLU is not packaging	The given PLU cannot be used in an operation for buying back returnable packaging.
Euro changeover not completed	If some steps for changeover to the euro were not performed, it's not possible to ring sales.
Discount/surcharge on subtotal	It's not possible to cancel the PLU because a discount/surcharge has already applied to the subtotal and the given PLU was included.
PLU cannot be cancelled	The entered PLU cannot be cancelled separately, but only together with the main PLU to which it is linked.
PLU cannot be sold	The entered PLU cannot be sold separately but only when linked to a main PLU.
Impossible payment value	The value entered for a payment cannot be realized in the valid banknotes and coins.
Invalid value	An extremely large value in the operation deposit, withdrawal or payment.
Payment limit exceeded	The value enters for payment cannot be processed.
Inappropriate payment method	Only cash can be used for payment in foreign currency.

Daily report completed	A daily Z-report was already run - no sales have been run since the last Z-report.
Run daily report	The activated operation requires the running of a daily Z-report.
Monthly report completed	Monthly Z-report was run.
Monthly report required	Activated operation requires the running of a monthly Z-report.
Z-report required	Activated operation requires running a Z-report.
Conditions for change not fulfilled	Value of data cannot be changed in the given state, for example, no reports have been run.
Prohibited step	During changeover to the euro, steps were requested, which in the given state of changeover are not allowed (status diagram for changeover to the euro).
Prohibited step	During changeover to the euro, steps were requested, which in the given state of changeover are not allowed (status diagram for changeover to the euro).
Perform configuration	While performing a step for the changeover to the euro, it is necessary to set/check a requested cash register configuration. It is not possible to use the register in the registration mode in this state. After setting/checking the configuration, it is necessary to repeat the given step for changeover.
Configuration not confirmed	While performing a step for the changeover to the euro, it was ascertained that a required setting/check for configuring the cash register was not performed.
Step was successful	Step for changeover to the euro was successfully done. Cash register can be used in the registration mode.
Report completed	The requested report was run.
No items entered	Operation does not contain a PLU
Error operation	Prohibited sequence of keys were pressed.
Pay out too high	The value of the payment causes a pay out value that cannot be shown on the customer display.
Continue registering	After switching on, the cash register informs about an open purchase – It is possible to continue in charging items or complete the sale.
Continue with payment	After switching on cash register informs about a purchase waiting to be paid – only payments are possible at this point.
Error in scale	Scale is not connected or communication with scale was unsuccessful.

Cannot find memory card	Error during export or import of data.
Cannot open file Cannot close file	
Cannot read file	
Cannot overwrite file	
Battery low connect adapter	Current state of the battery doesn't allow for regular cash register operation. Attaching an adapter is imperative. Cash register can be shut off.
Battery low charging...	Current state of the battery doesn't allow for regular cash register operation. Adapter is now attached. Cash register can be shut off.
Unsupported file system	SD card must be formatting for the FAT16 file system.

## TESTING THE CASH REGISTER

Tests for the Euro-50TE Mini allow you to simply and rapidly check the functionality of the cash register. With the help of self-tests, we can check the functioning of electronic circuits, display elements, keys and the keyboard and the printer. Only the most commonly used tests are described in this chapter. Other tests are designed for service technicians.

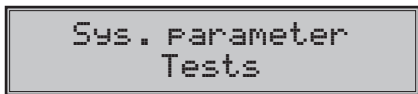

### Testing the electronic circuits and the display

#### Customer display

Self-test for the electronic circuits and the displays shows selected characters on the display.





#### Procedure for initiating the customer display test:

Sequence of steps	Display
In the P-mode press  or  and then  TOTAL to enter the menu for testing the customer display (P-mode - Sys. parameter - Tests):	Tests Customer displ.
Confirm by pressing  TOTAL. The customer display will gradually show selected characters.	Customer displ. working...
After successful completion of the test, the display reads:	Test OK

#### Cashier display

Self-test for the electronic circuits and the displays shows selected characters on the display.







**Procedure for initiating the test of the display operator:**

Sequence of steps	Displej obsluhy
In the P-mode, press  or  and then press  TOTAL to enter the menu for testing the cashier display (P-mode – Sys. parameter – Tests):	<pre> Tests Cashier disp1 </pre>
Confirm by pressing  TOTAL. The display will gradually light up all points on the cashier display.	
After successful completion of the cashier display test, the display reads.	<pre> Test OK </pre>

**Testing the keyboard**

The keyboard test evaluates the successive pressing of keyboard keys. If the keys are pressed in the exact order defined in Figure 7. 1 and the keyboard or its circuits are not damaged, the test will be completed successfully.

**Procedure for initiating the keyboard test:**

Sequence of steps	Display
In the P-mode press  or  and then press  TOTAL to enter the menu for testing the keyboard (P-mode – Sys. parameter – Tests):	<pre> Tests Keyboard </pre>
Confirm by pressing  TOTAL and gradually press the keys in the order shown in figure 7. 1. Begin with the  (MENU) key and end with the  TOTAL key.	<pre> Keyboard working... </pre>
After successful completion of the test, the display reads:	<pre> Test OK </pre>

**Course of the test:**

Gradually press the individual keyboard keys in the direction of the arrows in Figure 7. 1.

If a key is pressed in the incorrect order, a sound signal will announce the error until the correct key is pressed (the next according to the test).

You can end the keyboard test at any time by pressing  TOTAL.

Figure 7.1 – The Euro-50TE Mini keyboard



### Testing the printer

The printer's self-test will print out the entire set of characters in standard size with the related hexadecimal code on both the receipt ribbon and the journal ribbon.

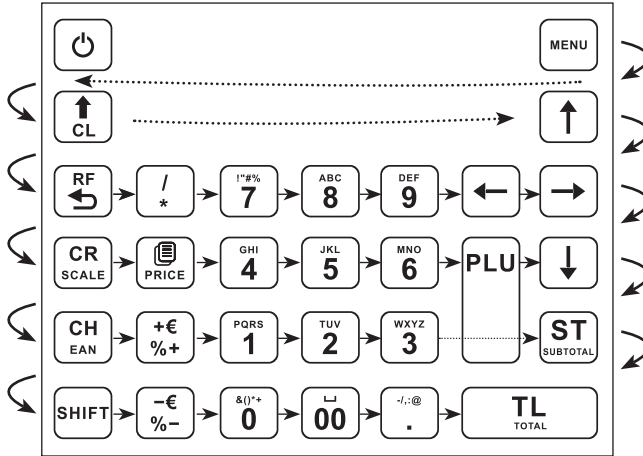
#### Procedure for initiating the printer's self-test:





Sequence of steps	Display
In the P-mode press  or  and press  TOTAL to enter the menu for the printer test (P-mode – Sys. parameter – Tests):	Tests Printer
Confirm by pressing  TOTAL. The printer will print out the cash register's character set on the thermal ribbon.	Printer working...
After successful completion of the test, the display reads:	Test OK

### Testing the position of thermal printer head

The display will show the current position of the printer head. Movement of the head's lifting mechanism changes the depiction of the head position on the display according to the actual position of the head's lifting mechanism.







**Procedure for initiating the test:**

Sequence of steps	Display
In the P-mode, press  or  and press  TOTAL to enter the menu for testing the position of the thermal printer head (P-mode – Sys. parameter – Tests):	Tests Head position
Confirm by pressing  TOTAL. If the printer head is in place, the display will show:	Head OK
If the printer head is lifted, the display will show:	Head raised
Complete the test by pressing  TOTAL.	Test OK

**Paper ribbon sensor test**

The display will show the current state of paper ribbons present in the sensors. Installing and removing paper from the sensors changes the status depicted on the display, depending on the presence of the paper in the sensor.

**Procedure for starting the test:**

Sequence of steps	Display
In the P mode, use the  or  buttons and press  TOTAL do menu pre test to enter the menu for testing the paper ribbon sensor (P-mode – Sys. parameter – Tests):	Tests Paper ribbons
Confirm by pressing  TOTAL. If both thermal ribbons are correctly inserted in the printer, this will appear on the display:	Paper OK žurnal OK
If there is an error in one of the thermal papers, the display will show	Paper OK žurnal error
Complete the test by pressing  TOTAL.	Test OK





